

Mod.
VI

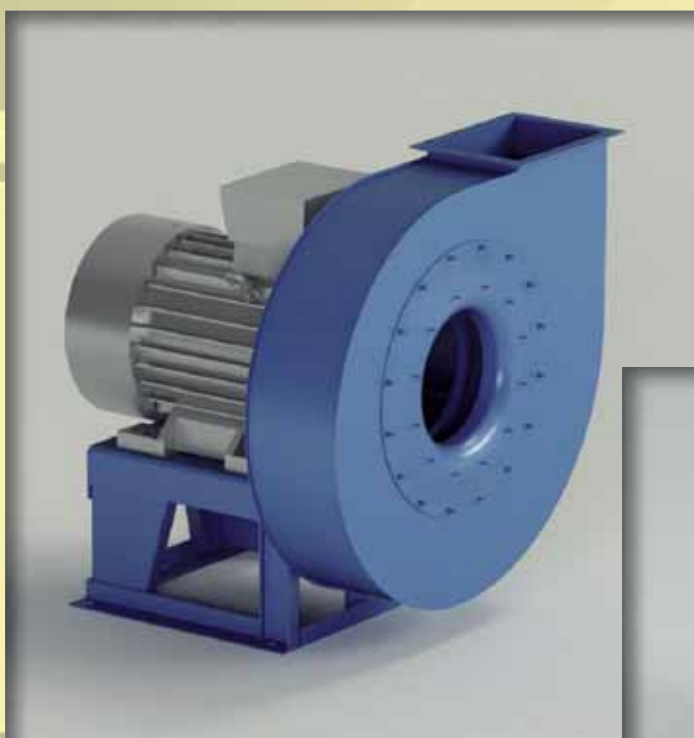

$Q = 850 \div 180000 \text{m}^3/\text{h}$

$Q = 0.24 \div 50 \text{m}^3/\text{s}$

$p_t = 100 \div 1800 \text{mmH}_2\text{O}$

$p_t = 1000 \div 18000 \text{Pa}$

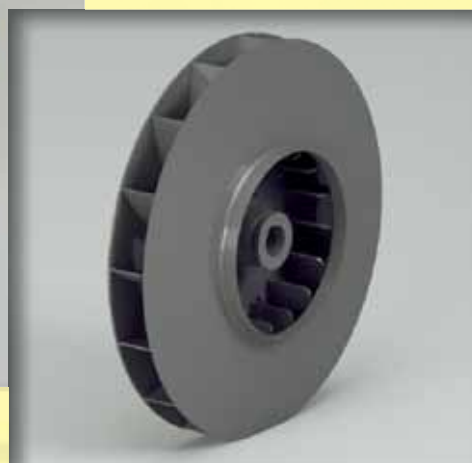

AERTECH S.R.L.

ITALIA - 20149 MILANO

Via Alberto Mario, 32

tel. +39.02.4989861 - fax. +39.02.43412240

www.aertech.it - info@aertech.it

Dealer MZ ASPIRATORI S.P.A.

Campo di lavoro

Portate basse-medie. Pressioni alte.

Tipo di pala

Curva, rovescia (negativa), vedi pag. 2.2.

Applicazioni

Per trasporto pneumatico, polveri, essiccazione, pressurizzazione. Adatto per impieghi nel campo industriale delle fonderie, pastifici, forni, chimico.

Esecuzioni costruttive standard

Es.1-Es.4-Es.5-Es.8-Es.9-Es.12, vedi pag. 2.5 - 2.6.

Temperature del fluido standard

-10÷+60°C. Per altre temperature vedi da pag. 1.12 a pag. 1.15.

Tipo di costruzione

Ventilatore in lamiera di Fe360, girante in Fe360 equilibrata staticamente e dinamicamente. Per altri materiali vedi da pag. 1.12 a pag. 1.15.

Dati di funzionamento

Condizioni dell'aria all'aspirazione T=20°C, 0m.s.l.m. e ρ=1.205 kg/m³.

Rumorosità

Espressa in potenza sonora L_{wA} [dB(A)] rilevata in campo libero con ventilatore canalizzato, vedi da pag. 1.40 a pag. 1.44.

Orientamenti

N°8 RD (rotazione oraria vista lato trasmissione) e N°8 LG. Ventilatore in versione imbullonata orientabile per le taglie 400-630, con supporto anteriore e quindi non orientabile dalla grandezza 710 a trasmissione, sempre orientabile nei ventilatori direttamente accoppiati senza supporto anteriore. Vedi pag. 2.7.

Costruzioni speciali

Vedi da pag. 2.20 a pag. 2.30.

Avviamento ventilatore

L'avviamento deve avvenire con ventilatore parzializzato, in funzione dell'assorbimento massimo del ventilatore.

Classi giranti

La seguente tabella fa riferimento a condizioni di lavoro standard. In condizioni di esercizio gravose si consiglia di contattare il servizio clienti di MZ Aspiratori per conoscere la tipologia di girante più idonea.

GRANDEZZA VENTILATORE • Grandeur • Size • Größe • Tamaño	RPM MASSIMO • Maxi tours/min. • Max rpm • Max. U/min • R.p.m. máx.		
	CLASSE I	CLASSE II	CLASSE III
VI400	5000		
VI450/R	5000		
VI450	5000		
VI500/R	4750		
VI500	4500	5000	
VI560/R	4250	4750	
VI560	4000	4500	
VI630/R	3850	4150	4500
VI630	3700	3900	4250
VI710/R	3550	3850	4150
VI710	3400	3700	4000
VI800/R	3250	3550	3850
VI800	3000	3300	3600
VI900/R	3200	3500	3700
VI900	3000	3250	3450
VI1000/R	3150	3350	3450
VI1000	3000	3150	3350
VI1120	2700	2900	3100
VI1250	2400	2600	2800
VI1400	2100	2300	2450
VI1600	1850	2000	2100
VI1800	1650	1750	1850
VI2000	1450	1550	1650

VALORI VALIDI FINO A 60°C

• Valeurs valables jusqu'à 60°C • Values valid up to 60°C
• Werte bis 60°C gültig • Valores válidos hasta 60°C

FRA	60°C	E	100°C	DECLASSARE VELOCITÀ	4%
• entre • between • zwischen • entre	100°C	• et • and • und • y	150°C	DECLASSARE VELOCITÀ	10%
	150°C		200°C	• déclasser vitesse	16%
	200°C		250°C	• dégrade speed	23%
	250°C		300°C	• Geschwindigkeit herabsetzen	30%
	300°C		350°C	• rebajar velocidad	37%
	350°C		400°C		45%
	400°C		450°C		54%
	450°C		500°C		64%

■ Domaine de travail

Débites faibles-moyens. Hautes pressions.

Type d'ailette

Courbée, inversée (négative), voir page 2.2.

Applications

Pour transport pneumatique, poussières, séchage, pressurisation. Convient à l'emploi dans le domaine industriel des fonderies, pasta factories, bakeries, chemicals.

Configurations de constructions standard

Ex.1- Ex.4- Ex.5- Ex.8- Ex.9- Ex.12, voir pages 2.5 - 2.6.

Températures du fluide standard

-10 ÷ +60°C. Pour d'autres températures voir pages 1.12-1.15.

Type de fabrication

Ventilateur en tôle de Fe360, turbine en Fe360 équilibrée statiquement et dynamiquement. Pour d'autres matériaux, voir pages 1.12-1.15.

Données de fonctionnement

Conditions de l'air à l'aspiration T=20°C, 0 m asl et ρ=1.205 kg/m³.

Niveau sonore

Exprimé en puissance sonore L_{wA} [dB(A)], relevé à l'air libre avec un ventilateur canalisé, voir pages 1.40 - 1.44.

Orientations

8 RD (rotation dans le sens des aiguilles d'une montre côté transmission) et 8 LG. Ventilateur en version boulonnée orientable pour les tailles 400-630, avec un support avant et donc non orientable de la grandeur 710 à transmission, toujours orientable dans les ventilateurs directement accouplés sans support avant. Voir page 2.7.

Fabrications spéciales

Voir pages 2.20-2.30.

Mise en marche du ventilateur

Le démarrage doit se faire avec un ventilateur partialisé, en fonction de l'absorption maximale du ventilateur.

Classes de turbines

Le tableau ci-dessus fait référence aux conditions de travail normales, en conditions de travail pénibles, on préconise de contacter le service clientèle de MZ Aspiratori pour connaître le type de turbine le plus adapté.

■ Field of operation

Medium-low flow rates. High pressures.

Blade type

Curve, backward (negative), see pg. 2.2.

Applications

For pneumatic transport, dust, drying, pressurization. Suitable for applications in industrial fields like foundries, pasta factories, bakeries, chemicals.

Standard constructional arrangements

Arr.1 - Arr.4 - Arr.5 - Arr.8 - Arr.9 - Arr.12, see pgs. 2.5 - 2.6.

Standard fluid temperatures

-10÷+60°C. For other temperatures see pgs. 1.12 to 1.15.

Type of construction

Fan in Fe360 plate, impeller in Fe360 statically and dynamically balanced. For other materials see pgs. 1.12 to 1.15.

Operating specifications

Condition of inlet air T=20°C, 0 m above sea level and ρ=1.205 kg/m³.

Noise level

Expressed as sound power L_{wA} [dB(A)] measured in free field with ducted fan, see pgs. 1.40 to 1.44.

Orientations

No.8 RD (clockwise viewed from transmission side) and No.8 LG. Fan in bolted orientable version for sizes 400-630, with front support and so not orientable for sizes 710 and above with transmission drive, always orientable for directly coupled fans without front support. See pg. 2.7.

Special applications

See pgs. 2.20 to 2.30.

Fan start-up

During start-up the fan flow rate must be limited, calibrated for the fan's maximum electrical input.

Impeller classes

The above table refers to standard operating conditions, in heavy-duty service conditions it is advisable to contact the MZ Aspiratori Customer Service to establish the most suitable type of impeller.

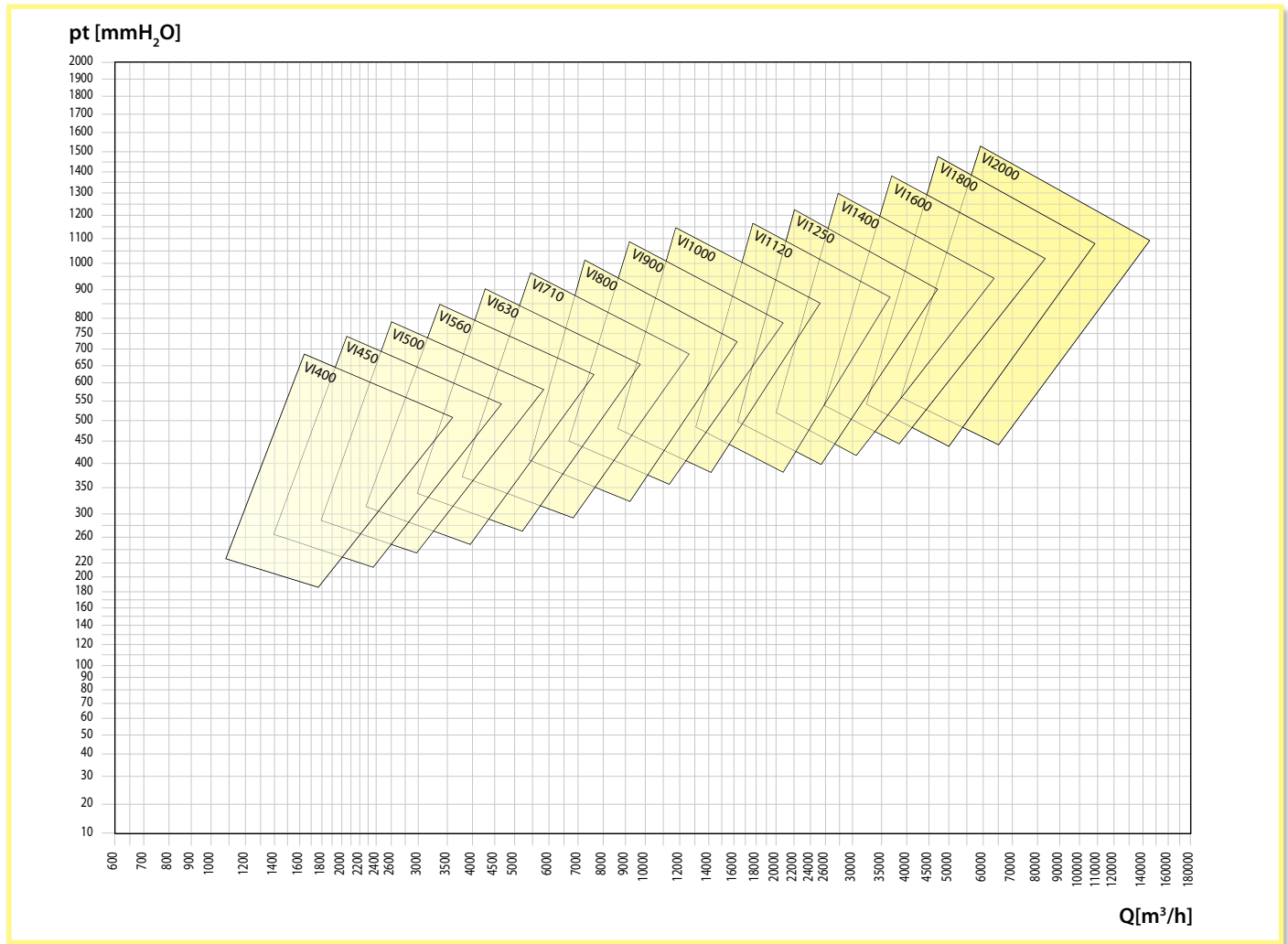

Arbeitsbereich

Niedrige - mittlere Fördermengen. Hohe Drücke.

Schaufelform

Kurve, rückwärts gekrümmt (negativ), siehe Seite 2.2.

Anwendungen

Zum Transport von Stäuben, zur Trocknung und für mit Überdruck zu beaufschlagende Räume. Zur Verwendung im industriellen Bereich, Giessereien, Nudelfabriken, Öfen und der Chemie geeignet.

Konstruktive Standardausführungen

Ausf. 1-Ausf. 4-Ausf. 5-Ausf. 8-Ausf. 9-Ausf. 12, siehe Seiten 2.5 - 2.6.

Standardtemperatur des Mediums

-10 ÷ +60°C. Für andere Temperaturen siehe Seiten 1.12 bis 1.15.

Konstruktionsart

Ventilator aus Blech Fe360, Laufrad aus Fe360, statisch und dynamisch ausgewuchtet. Für andere Materialien siehe Seiten 1.12 bis 1.15.

Betriebsdaten

Physikalischer Zustand der Ansaugluft T = 20°C, 0 m ü. M. und ρ = 1.205 kg/m³.

Geräuschpegel

Angegeben als Schalleistungspegel L_{w,A} [dB(A)] mit Messung im Freifeld und an Rohren angeschlossenem Ventilatore, siehe Seiten 1.40 bis 1.44.

Ausrichtung

8 Modelle RD (Drehrichtung im Uhrzeigersinn, von Antriebsseite aus gesehen) und 8 Modelle LG. Angeschraubter, in der Ausrichtung veränderbarer Ventilator in den Grössen 400-630, mit Vorderstütze und damit nicht veränderbar ab Grösse 710 mit Riementrieb, immer ausrichtbar bei allen direkt angetriebenen Ventilatoren ohne Vorderstütze, siehe Seite 2.7.

Spezialausführungen

Siehe Seiten 2.20 bis 2.30.

Ventilator-Anlauf

Der Ventilatoranlauf muss bei teilweise geschlossenem Ventilator erfolgen, in Abhängigkeit von der maximalen Stromaufnahme des Motors.

Laufradklassen

Die obenstehende Tabelle bezieht sich auf normale Betriebsbedingungen. Bei erschwerenden Betriebsbedingungen wird empfohlen, den Kundenservice der MZ Aspiratori zu kontaktieren, um den am besten geeigneten Laufradtyp zu bestimmen.

Campo de trabajo

Caudales bajo-medios. Presiones altas.

Tipo de pala

Curva, invertida (negativa), ver pág. 2.2.

Aplicaciones

Para transporte neumático, polvos, desecación y presurización. Apto para el uso en el campo industrial: fundiciones, fábricas de pasta, hornos e industria química.

Variantes constructivas estándares

Ejec. 1-Ejec. 4-Ejec. 5-Ejec. 8-Ejec. 9-Ejec. 12, ver págs. 2.5 - 2.6.

Temperaturas del fluido estándares

De -10 a +60°C. Para otras temperaturas, ver págs. de 1.12 a 1.15.

Tipo de construcción

Ventilador de chapa en Fe360, rotor en Fe360 equilibrado estática y dinámicamente. Para otros materiales, ver págs. de 1.12 a 1.15.

Datos de funcionamiento

Condiciones del aire en aspiración T = 20°C, 0 m SNM y ρ = 1.205 kg/m³.

Niveles de ruido

Expresados en potencia sonora L_{w,A} [dB(A)] medida en campo abierto con ventilador canalizado, ver págs. de 1.40 a 1.44.

Orientaciones

8 RD (rotación dextrógira vista desde el lado de transmisión) y 8 LG. Ventilador en versión emperrada orientable para tamaños 400 - 630, con soporte delantero, por lo cual no es orientable a partir del tamaño 710 de transmisión, siempre orientable en ventiladores acoplados directamente sin soporte delantero. Ver pág. 2.7.

Construcciones especiales

Ver págs. de 2.20 a 2.30.

Puesta en marcha del ventilador

La puesta en marcha debe efectuarse con ventilador parcializado, en función de la absorción máxima del ventilador.

Clases de rotores

La tabla arriba hace referencia a condiciones de trabajo estándares, en condiciones de funcionamiento pesadas, se aconseja llamar al Servicio de atención al cliente de MZ Aspiratori para conocer el tipo de rotor más adecuado.

Tipo • Type • Type • Typ • Tipo		P inst. [kW]	n	LpA [dB(A)]	Tolleranza sulla portata ±5% • Tolérance sur le débit ±5% • Load tolerance ±5% • Durchsatztoleranz ±5% • Tolerancia respecto caudal ±5%													
Ventilatore • Ventilateur • Fan • Ventilator • Ventilador	Motore • Moteur • Motor • Motor • Motor				Q [m³/h]													
					935	1080	1225	1370	1440	1620	1800	2160	2520	2880	3240	3600	3960	4320
					pt[mmH ₂ O]													
VI400/N2	90	2,2	2920	62	272	270	267	262	258	252	244	224	196	166				
VI450/N2	112	4	2940	66					348	343	339	332	316	301	275	250	216	
VI500/N2R	112	4	2940	67							374	370	358	340	326	311	282	
VI500/N2R	132	5,5	2950	67							376	372	360	342	328	313	284	254
VI500/N2	132	5,5	2950	70								430	421	413	401	392	372	352
VI500/N2	132	7,5	2960	70								432	423	415	403	394	374	354
VI560/N2R	132	7,5	2960	71									485	480	475	462	454	438
VI560/N2	160	11	2960	72										545	540	533	527	518
VI630/N2R	160	15	2960	72												605	600	590
VI630/N2R	160	18,5	2960	73												605	600	590
VI630/N2	160	18,5	2960	74													700	690
VI630/N2	180	22	2960	75													700	690
VI710/N2R	180	22	2960	75														
VI710/N2R	200	30	2960	76														
VI710/N2	200	30	2960	77														
VI710/N2	200	37	2960	78														
VI800/N2R	225	45	2960	76														
VI800/N2R	250	55	2960	82														
VI800/N2	250	55	2960	82														
VI800/N2	280	75	2970	83														
VI900/N2R	280	90	2970	83														
VI900/N2	315	110	2980	84														
VI1000/N2R	315	160	2980	85														
VI1000/N2	315	200	2980	86														

Il livello di pressione sonora ponderato A, LpA (cap.13), corrisponde al valore rilevato, nelle condizioni di prova, nel punto di massima rumorosità.

Tolleranza sulla rumorosità ±4dB(A)
 • Tolérance sur le bruit ±4dB(A) • Noise tolerance ±4dB(A)
 • Geräushtoleranz ±4dB(A) • Tolerancia respecto a ruido ±4dB(A)

Q [m³/h]																		
4680	5400	6120	7200	7920	9000	10080	10800	12600	14400	16200	18000	19800	21600	25200	28800	30600	37000	42500
pt[mmH ₂ O]																		
230																		
335	277																	
424	385	340																
504	480	445	382	330														
580	565	540	495															
580	565	540	495	454	390													
683	668	652	626	594	552													
683	668	652	626	594	552	495	455											
780	775	765	744	724	684													
780	775	765	744	724	684	650	622	530										
	885	878	860	848	826	795	773											
	885	878	860	848	826	795	773	725	626	530								
			1120	1110	1096	1080	1060	1020										
			1120	1110	1096	1080	1060	1020	960	886	795	695	580					
				1205	1195	1182	1170	1145	1100									
				1215	1205	1192	1180	1155	1110	1060	980	900	790					
								1430	1430	1415	1376	1325	1275					
								1530	1530	1525	1508	1475	1440	1397	1265	1142	1020	
									1733	1737	1733	1718	1693	1606	1510	1425	1150	
										1890	1890	1885	1875	1815	1730	1682	1460	1244

■ Le niveau de pression sonore pondérée A, LpA (chap. 13), correspond à la valeur relevée dans les conditions d'essai au point de niveau sonore maximum.
 ■ Der nach A bewertete Schalldruckpegel LpA (Kap. 13) entspricht in den Testbedingungen dem höchsten gemessenen Wert des Geräuschpegels.

■ The A-weighted sound power level, LpA (Chap.13), is the value measured in test conditions at the point of maximum noise level.
 ■ El nivel de presión sonora ponderado A, LpA (cap. 13), corresponde al valor medido, en las condiciones de prueba, en el punto con máximos niveles de ruido.

Tipo • Type • Type • Typ • Tipo		P inst. [kW]	n	LpA [dB(A)]	Tolleranza sulla portata ±5% • Tolérance sur le débit ±5% • Load tolerance ±5% • Durchsatztoleranz ±5% • Tolerancia respecto caudal ±5%													
Ventilatore • Ventilateur • Fan • Ventilator • Ventilador	Motore • Moteur • Motor • Motor • Motor				Q [m³/h]													
					935	1080	1225	1370	1440	1620	1800	2160	2520	2880	3240	3600	3960	4320
					pt[mmH ₂ O]													
VI400/N2	90	2,2	2920	62	263	261	257	252	248	241	232	210	179	146				
VI450/N2	112	4	2940	66					334	329	324	316	299	282	255	227	191	
VI500/N2R	112	4	2940	67							358	354	341	323	308	291	262	
VI500/N2R	132	5,5	2950	67							360	355	343	324	309	293	263	232
VI500/N2	132	5,5	2950	70								409	400	391	378	368	347	325
VI500/N2	132	7,5	2960	70								411	401	393	380	369	349	327
VI560/N2R	132	7,5	2960	71									460	454	449	435	427	410
VI560/N2	160	11	2960	72										514	508	500	493	484
VI630/N2R	160	15	2960	72												567	562	552
VI630/N2R	160	18,5	2960	73												567	562	552
VI630/N2	160	18,5	2960	74													651	641
VI630/N2	180	22	2960	75													651	641
VI710/N2R	180	22	2960	75														
VI710/N2R	200	30	2960	76														
VI710/N2	200	30	2960	77														
VI710/N2	200	37	2960	77														
VI800/N2R	225	45	2960	76														
VI800/N2R	250	55	2960	80														
VI800/N2	250	55	2960	80														
VI800/N2	280	75	2970	81														
VI900/N2R	280	90	2970	81														
VI900/N2	315	110	2980	82														
VI1000/N2R	315	160	2980	83														
VI1000/N2	315	200	2980	84														

Il livello di pressione sonora ponderato A, LpA (cap.13), corrisponde al valore rilevato, nelle condizioni di prova, nel punto di massima rumorosità.

Tolleranza sulla rumorosità ±4dB(A)
 • Tolérance sur le bruit ±4dB(A) • Noise tolerance ±4dB(A)
 • Geräushtoleranz ±4dB(A) • Tolerancia respecto a ruido ±4dB(A)

Q [m³/h]																		
4680	5400	6120	7200	7920	9000	10080	10800	12600	14400	16200	18000	19800	21600	25200	28800	30600	37000	42500
pt[mmH ₂ O]																		
206																		
307	245																	
396	355	308																
469	443	407	340	284														
542	526	501	454															
542	526	501	454	413	346													
634	618	601	573	541	497													
634	618	601	573	541	497	437	394											
721	715	705	684	664	625													
721	715	705	684	664	625	590	562	469										
	810	802	784	772	749	718	696											
	810	802	784	772	749	718	696	645	545	445								
			1005	996	982	967	948	910										
			1005	996	982	967	948	910	854	784	697	599	483					
				1073	1063	1050	1039	1014	971									
				1081	1071	1058	1047	1022	980	932	857	780	673					
								1250	1247	1233	1199	1155	1111					
								1327	1324	1318	1302	1273	1242	1204	1088	973	862	
									1478	1479	1475	1462	1441	1370	1289	1219	978	
										1591	1589	1584	1574	1526	1457	1418	1231	1037

■ Le niveau de pression sonore pondérée A, LpA (chap. 13), correspond à la valeur relevée dans les conditions d'essai au point de niveau sonore maximum.

■ Der nach A bewertete Schalldruckpegel LpA (Kap. 13) entspricht in den Testbedingungen dem höchsten gemessenen Wert des Geräuschpegels.

■ The A-weighted sound power level, LpA (Chap.13), is the value measured in test conditions at the point of maximum noise level.

■ El nivel de presión sonora ponderado A, LpA (cap. 13), corresponde al valor medido, en las condiciones de prueba, en el punto con máximos niveles de ruido.



ASPIRATORI

■ DIMENSIONS D'ENCOMBREMENT ET POIDS/COURBES DE FONCTIONNEMENT ■ OVERALL DIMENSIONS AND WEIGHT/WORKING CURVES ■ AUSMAßE UND GEWICHTE/FUNKTIONSKURVEN ■ DIMENSIONES QUE OCUPA Y PESOS/CURVAS DE FUNCIONAMIENTO

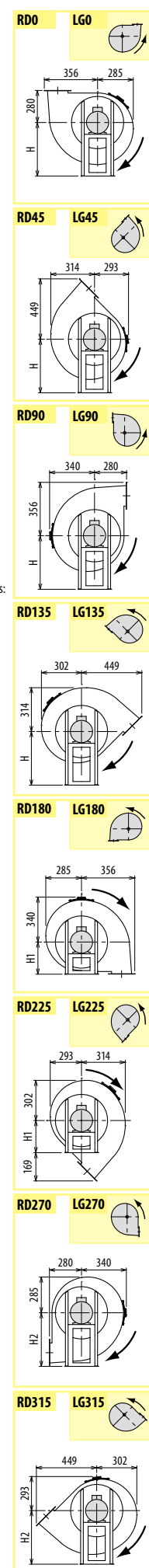
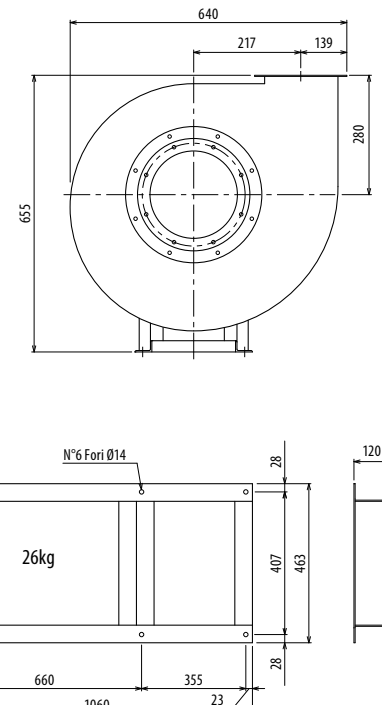
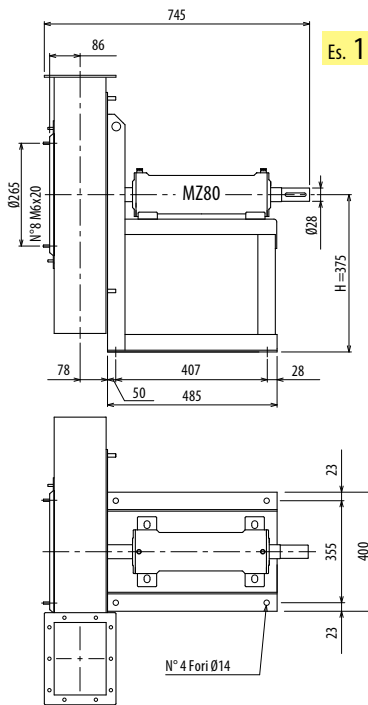
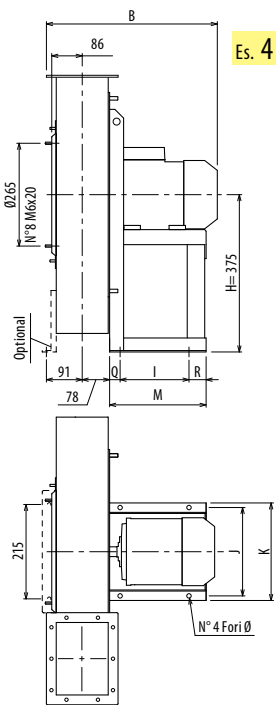

Il ventilatore è orientabile • Peso in tabella comprensivo di motore

- Le ventilateur est orientable
- The fan is revolvable
- Der Ventilator ist drehbar
- El ventilador es orientable
- The weight indicated in the table includes motor
- Gewichtsangabe in Tabelle inkl. Motor
- El peso en la tabla incluye el motor

Ulteriori informazioni e quote:
 ■ Ulérieures informations et cotes:
 ■ Further information and sizes:
 ■ Weitere Infos und Größen:
 ■ Más informaciones y medidas:

TIPO - Type		PESO Weight	PD ²											
VENTILATORE Fan	MOTORE Motor	Kg	Kgf x m ²	B	I	H	H1	H2	J	K	M	Q	R	Ø
VI400/N2	90 L2	50	0,7	468	133	375	280	375	234	260	246	55	58	10
VI400/N/T		67	0,70			375	280	375						

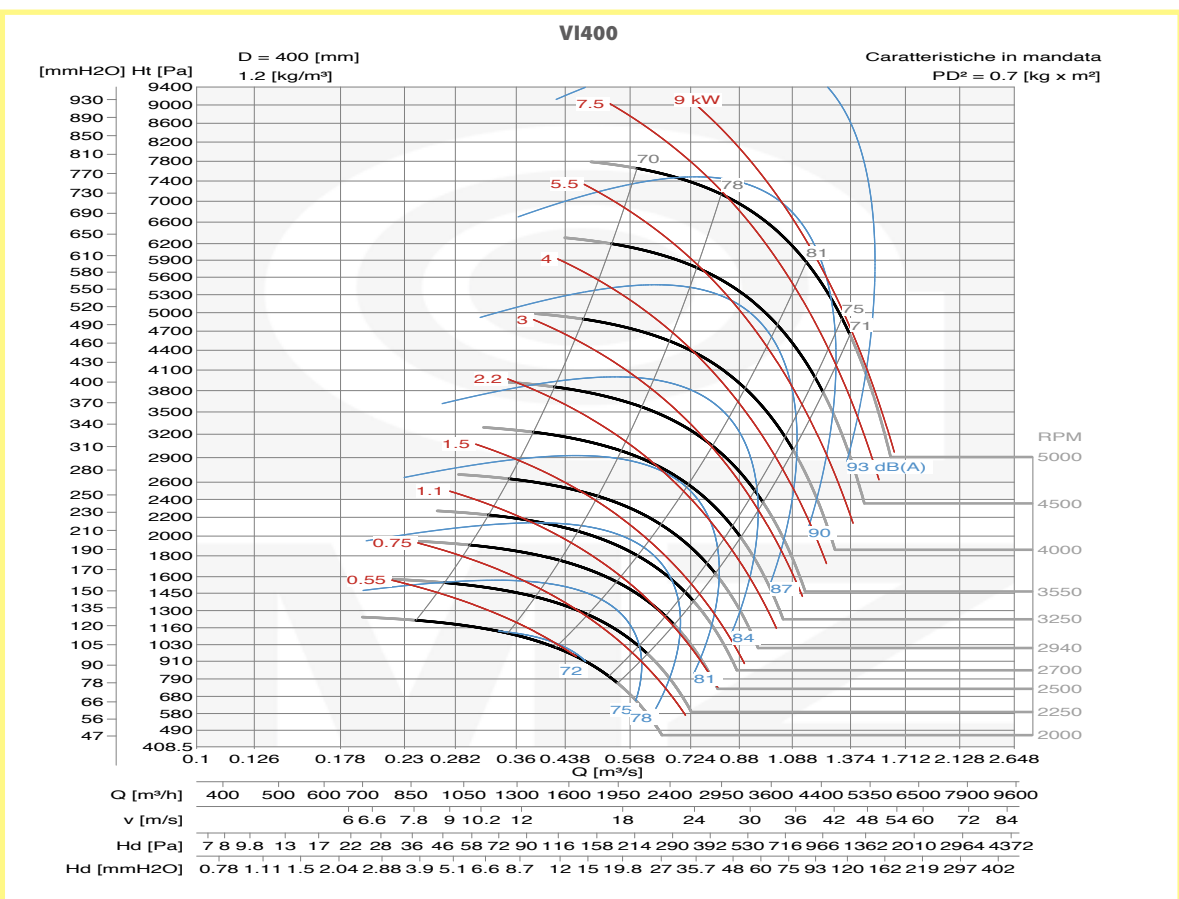
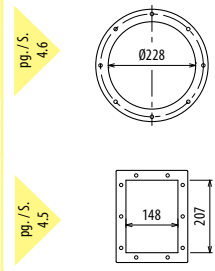

VI

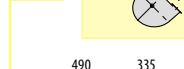
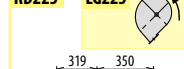
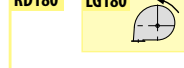
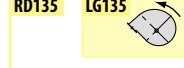
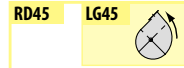
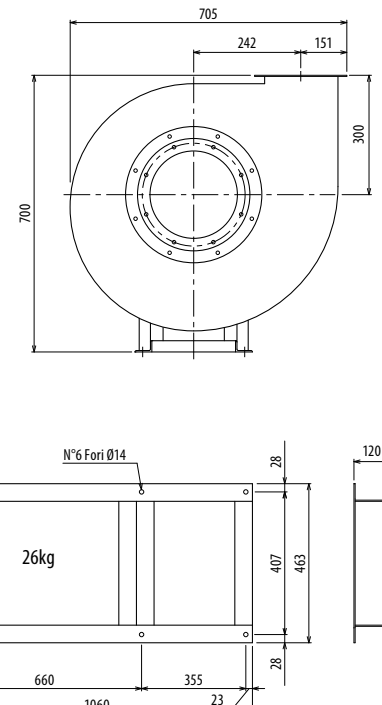
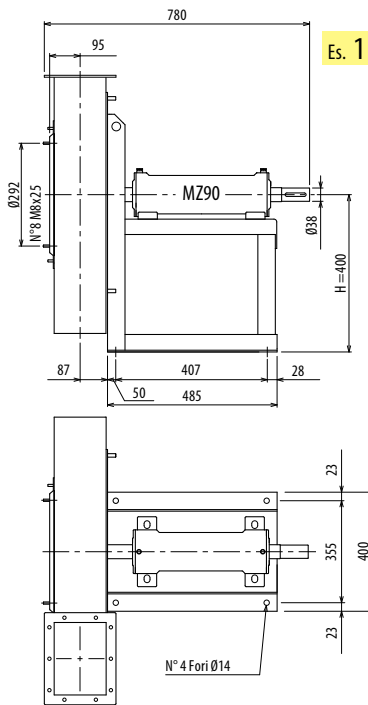
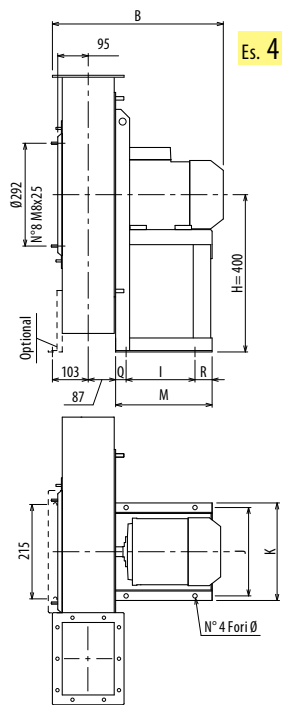

Il ventilatore è orientabile • Peso in tabella comprensivo di motore

- Le ventilateur est orientable
- The fan is revolvable
- Der Ventilator ist drehbar
- El ventilador es orientable
- The weight indicated in the table includes motor
- Gewichtsgabe in Tabelle inkl. Motor
- El peso en la tabla incluye el motor

Ulteriori informazioni e quote:
 ■ Ulérieures informations et cotes:
 ■ Further information and sizes:
 ■ Weitere Infos und Größen:
 ■ Más informaciones y medidas:

TIPO - Type		PESO Weight	PD ²	B	I	H	H1	H2	J	K	M	Q	R	Ø
VENTILATORE Fan	MOTORE Motor	Kg	Kgf x m ²											
VI450/N2	112 M2	83	1,0	538	197	400	300	400	289	324	276	30	49	12
VI450/N/T		76	1,0			400	300	400						

pg. / s. 4,6

pg. / s. 4,5

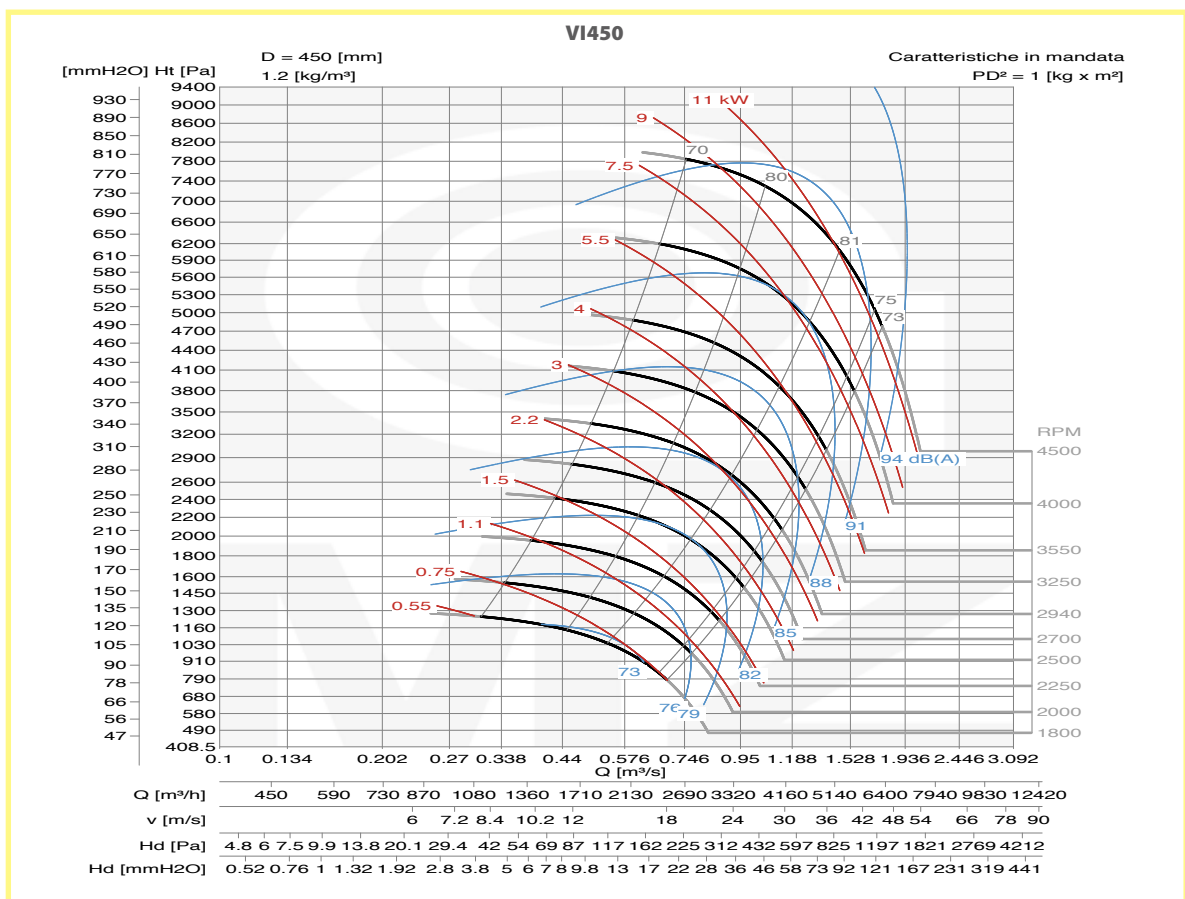
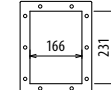
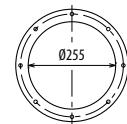

VI

VI500/N

DIMENSIONI D'INGOMBRO E PESI/CURVE DI FUNZIONAMENTO

■ DIMENSIONS D'ENCOMBREMENT ET POIDS/COURBES DE FONCTIONNEMENT ■ OVERALL DIMENSIONS AND WEIGHT/WORKING CURVES ■ AUSMAßE UND GEWICHTE/FUNKTIONSKURVEN ■ DIMENSIONES QUE OCUPA Y PESOS/CURVAS DE FUNCIONAMIENTO

Es. 4

Es. 1

Il ventilatore è orientabile • Peso in tabella comprensivo di motore

■ Le ventilateur est orientable ■ The fan is revolvable ■ Der Ventilator ist drehbar ■ El ventilador es orientable
 Le poids dans le tableau inclut le moteur The weight indicated in the table includes motor Gewichtsgabe in Tabelle inkl. Motor El peso en la tabla incluye el motor

Ulteriori informazioni e quote:
 ■ Ulérieures informations et cotes:
 ■ Further information and sizes:
 ■ Weitere Infos und Größen:
 ■ Más informaciones y medidas:

TIPO - Type		PESO Weight	PD ²											
VENTILATORE Fan	MOTORE Motor	Kg	Kgf x m ²	B	I	H	H1	H2	J	K	M	Q	R	Ø
VI500/N2R	112 M2	94	1,4	557	197	450	335	450	289	324	276	30	49	12
VI500/N2R	132 SA2	108	1,4	597	237	450	335	450	337	372	336	40	59	12
VI500/N2	132 SA2	109	1,7	597	237	450	335	450	337	372	336	40	59	12
VI500/N2	132 SB2	109	1,7	597	237	450	335	450	337	372	336	40	59	12
VI500/N/T		91	1,7			450	335	450						

VI500

D = 500 [mm]
 1.2 [kg/m³]

Caratteristiche in mandata
 PD² = 1.7 [kg x m²]

Q [m ³ /h]	840	1020	1290	1560	1920	2370	2910	3540	4260	5160	6240	7590	9210	11370	14340										
v [m/s]	7	8.2	9.4	11.2	13	19	25	31	37	43	49	55	61	73	85										
Hd [Pa]	12	15	19.8	27	33	42	54	66	81	99	126	168	225	300	399	531	708	942	1308	1893	2742	3969			
Hd [mmH2O]	1.2	1.6	2.4	3.3	4.6	6	7	8.9	11	14	18	22	27	33	41	50	61	75	92	118	157	209	278	370	492

VI

3.VI/10

COPYRIGHT N.2012001578 MZASPIRATORI SPA

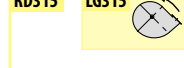
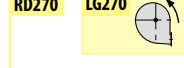
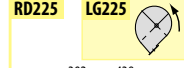
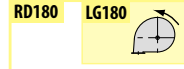
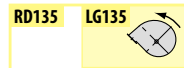
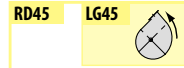
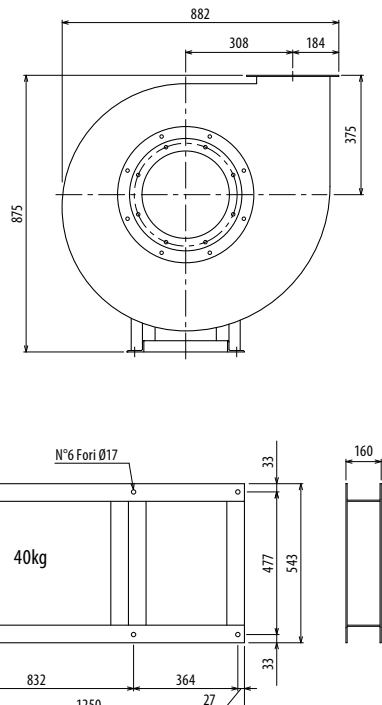
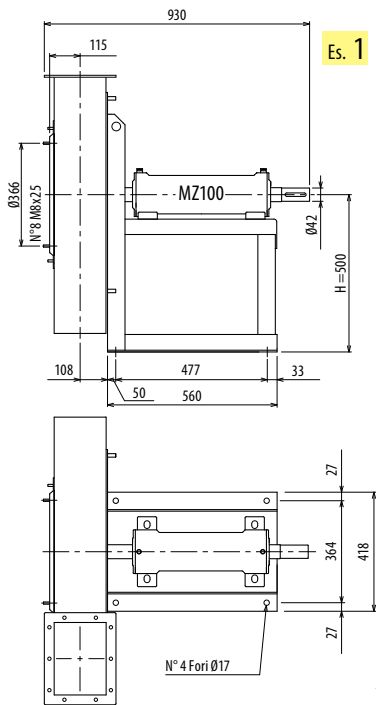
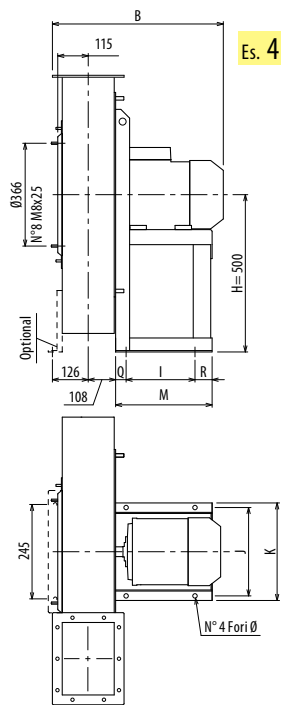

Il ventilatore è orientabile • Peso in tabella comprensivo di motore

- Le ventilateur est orientable
- The fan is revolvable
- Der Ventilator ist drehbar
- El ventilador es orientable

Ulteriori informazioni e quote:
 ■ Ulérieures informations et cotes:
 ■ Further information and sizes:
 ■ Weitere Infos und Größen:
 ■ Más informaciones y medidas:

TIPO - Type		PESO Weight	PD ²	B	I	H	H1	H2	J	K	M	Q	R	Ø
VENTILATORE Fan	MOTORE Motor	Kg	Kgf x m ²											
VI560/N2R	132 SB2	123	2,2	623	237	500	375	500	337	372	336	40	59	12
VI560/N2	132 MB2	143	2,6	623	237	500	375	500	337	372	336	40	59	12
VI560/N2	160 MA2	166	2,6	728	337	500	375	500	395	440	436	50	49	14
VI560/N/T		117	2,6			500	375	500						

pg. / s. 4,6
 pg. / s. 4,5

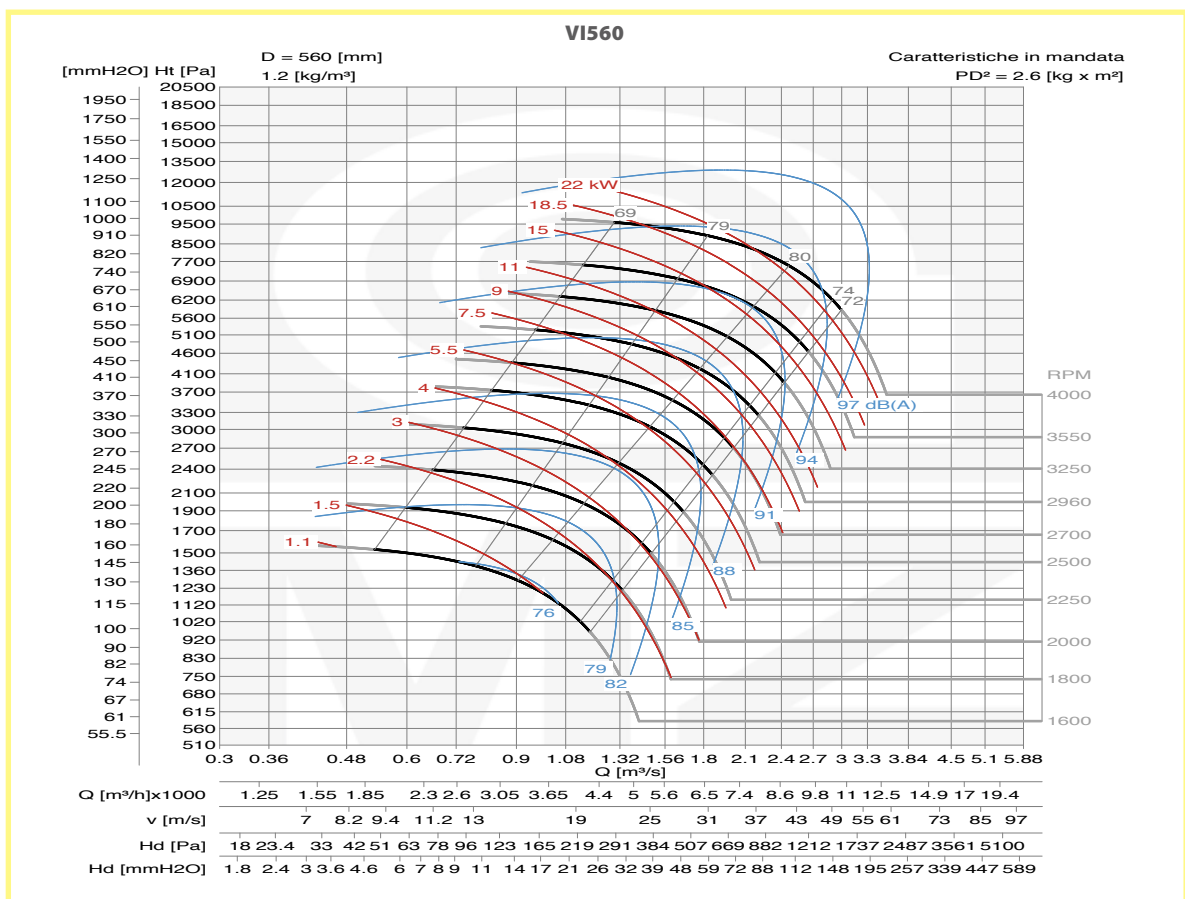
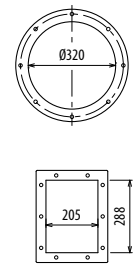

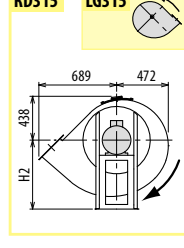
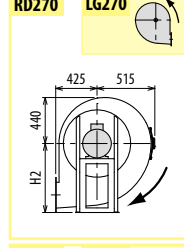
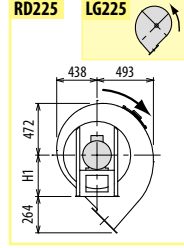
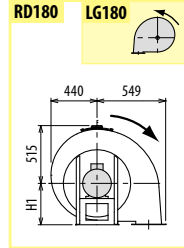
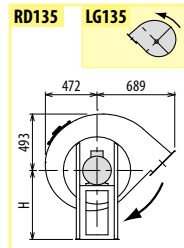
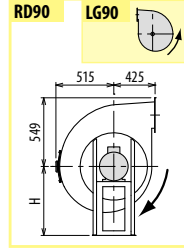
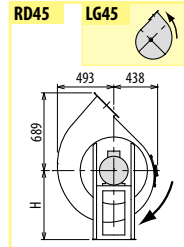
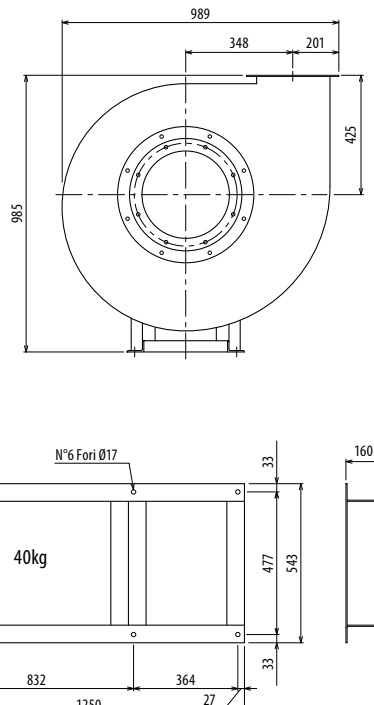
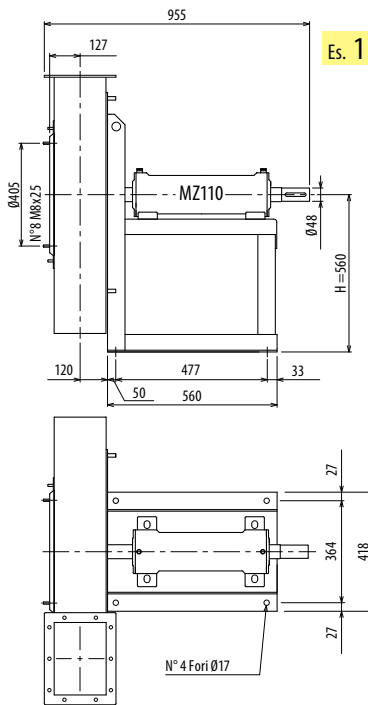
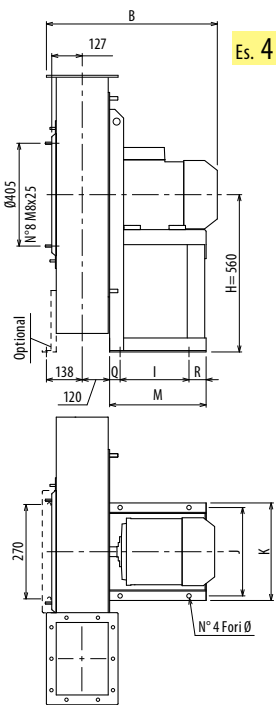

Il ventilatore è orientabile • Peso in tabella comprensivo di motore

- Le ventilateur est orientable
 - The fan is revolvable
 - Der Ventilator ist drehbar
 - El ventilador es orientable
- Le poids dans le tableau inclut le moteur The weight indicated in the table includes motor Gewichtsangabe in Tabelle inkl. Motor El peso en la tabla incluye el motor

Ulteriori informazioni e quote:
 ■ Ulteriori informazioni e cotes:
 ■ Further information and sizes:
 ■ Weitere Infos und Größen:
 ■ Más informaciones y medidas:

TIPO - Type		PESO Weight	PD ²	B	I	H	H1	H2	J	K	M	Q	R	Ø
VENTILATORE Fan	MOTORE Motor	Kg	Kgf x m ²											
VI630/N2R	160 MB2	190	3,6	752	337	560	425	560	395	440	436	50	49	14
VI630/N2R	160 L2	198	3,6	752	337	560	425	560	395	440	436	50	49	14
VI630/N2	160 L2	200	4,3	752	337	560	425	560	395	440	436	50	49	14
VI630/N2	180 M2	266	4,3	833	357	560	425	560	434	488	460	70	33	17
VI630/N/T		158	4,3			560	425	560						

pg. / s. 4,6

pg. / s. 4,5

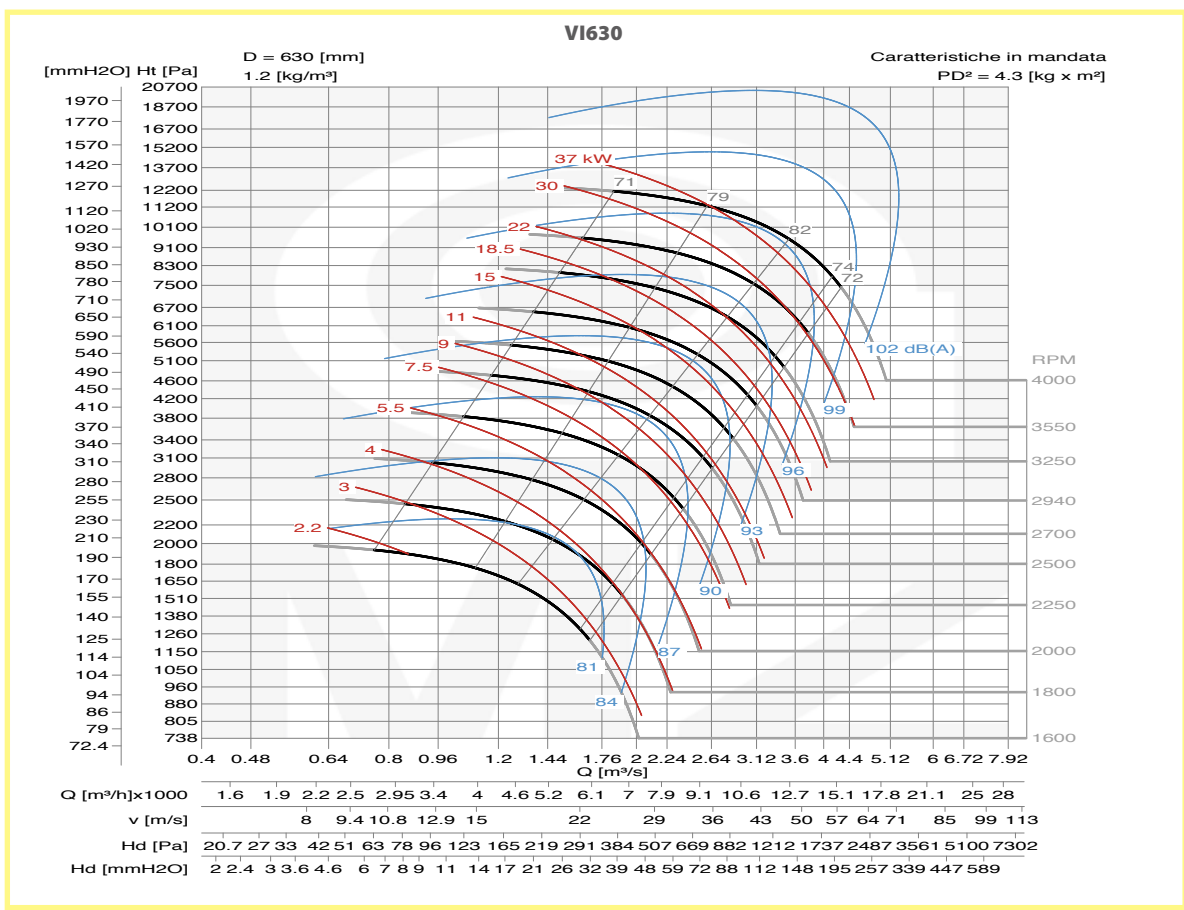
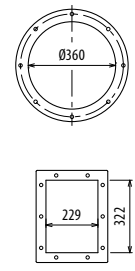

VI

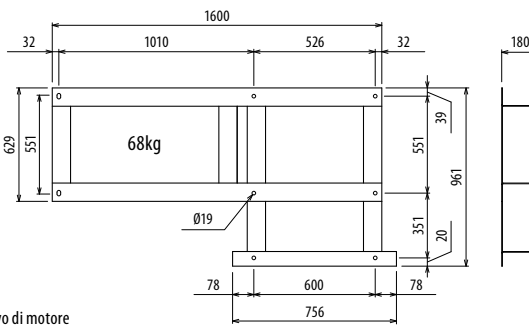
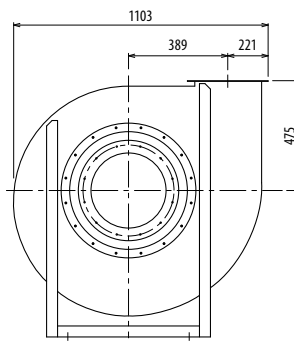
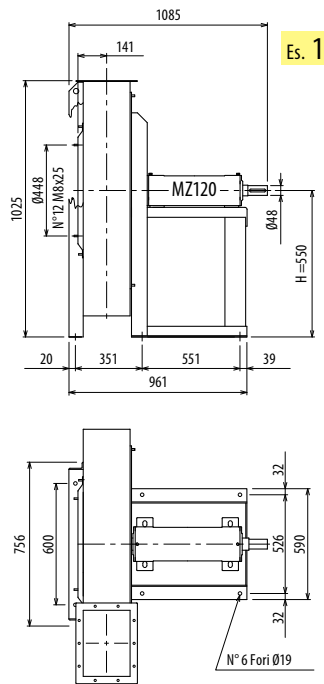
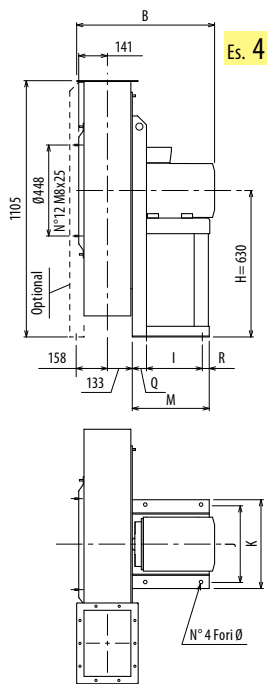

Il ventilatore in ES. 4 senza supporto anteriore è orientabile, in ES. 1 non è orientabile • Peso in tabella comprensivo di motore

■ Le ventilateur en Ex. 4 sans support frontal est orientable, en Ex. 1 n'est pas orientable.
 Le poids dans le tableau inclut le moteur
 ■ Der Ventilator in Aus. 4, ohne Vorderhalterung, ist drehbar; in Aus. 1 ist nicht drehbar.
 Gewichtsangabe in Tabelle inkl. Motor

■ The fan in Ex. 4 without front support is revolvable, in Ex. 1 is not revolvable.
 The weight indicated in the table includes motor
 ■ El ventilador en Ej. 4 sin soporte delantero es orientable, en Ej. 1 no es orientable.
 El peso en la tabla incluye el motor

Ulteriori informazioni e quote:
 ■ Ulteriores informations et cotes:
 ■ Further information and sizes:
 ■ Weitere Infos und Größen:
 ■ Más informaciones y medidas:

TIPO - Type		PESO Weight	PD ²											
VENTILATORE Fan	MOTORE Motor	Kg	Kgf x m ²	B	I	H	H1	H2	J	K	M	Q	R	Ø
VI710/N2R	180 M2	298	7,8	860	357	630	475	630	434	488	460	70	33	17
VI710/N2R	200 LA2	391	7,8	968	381	630	475	630	506	568	500	80	39	19
VI710/N2	200 LA2	394	10	968	381	630	475	630	506	568	500	80	39	19
VI710/N2	200 LB2	394	10	968	381	630	475	630	506	568	500	80	39	19
VI710/N/T		272	10			550	475	630						

pg. / s. 4,6

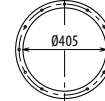

pg. / s. 4,5

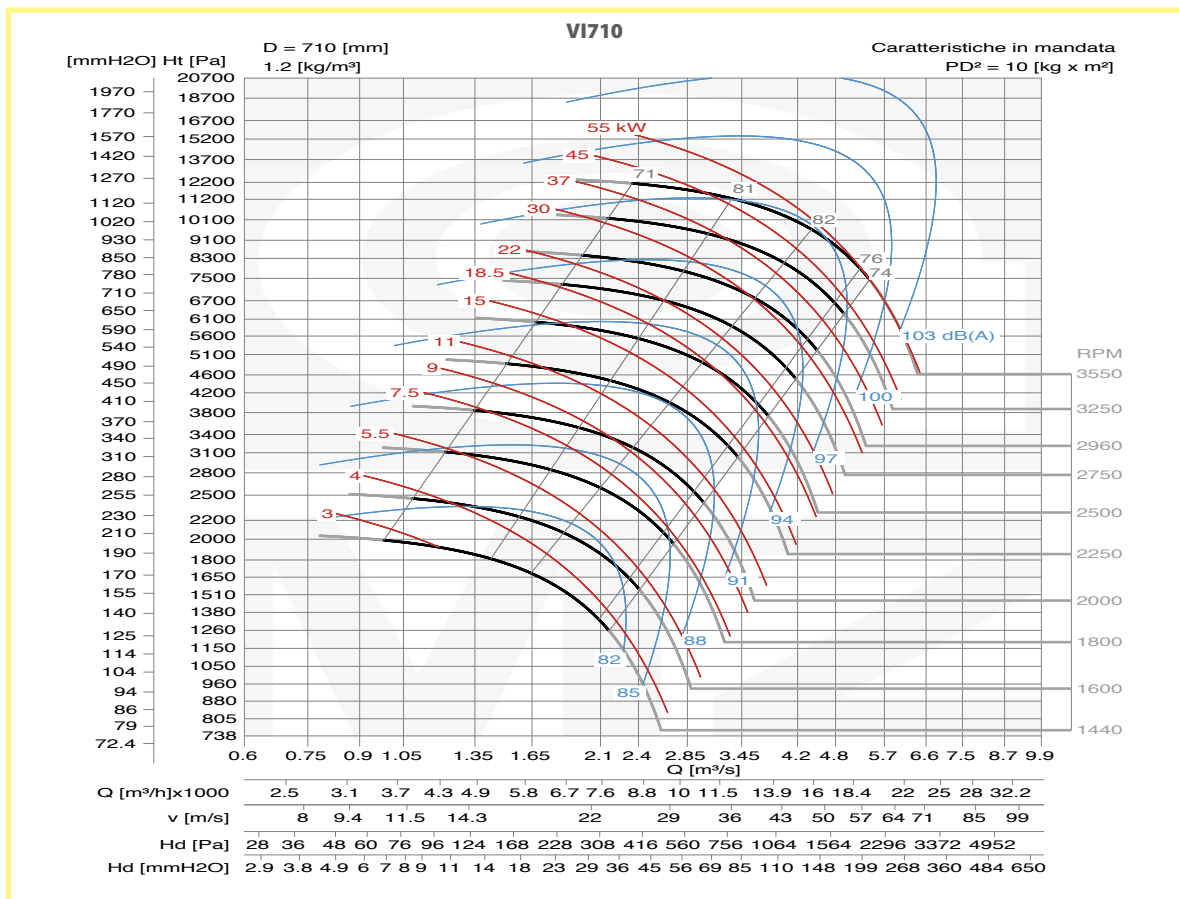
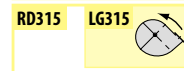
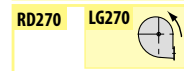
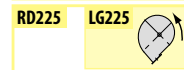
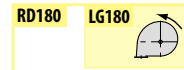
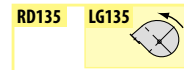
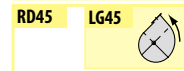
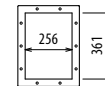

VI



ASPIRATORI

■ DIMENSIONS D'ENCOMBREMENT ET POIDS/COURBES DE FONCTIONNEMENT ■ OVERALL DIMENSIONS AND WEIGHT/WORKING CURVES ■ AUSMAßE UND GEWICHTE/FUNKTIONSKURVEN ■ DIMENSIONES QUE OCUPA Y PESOS/CURVAS DE FUNCIONAMIENTO

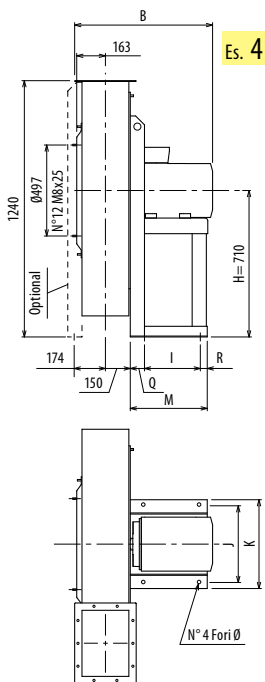

Es. 4

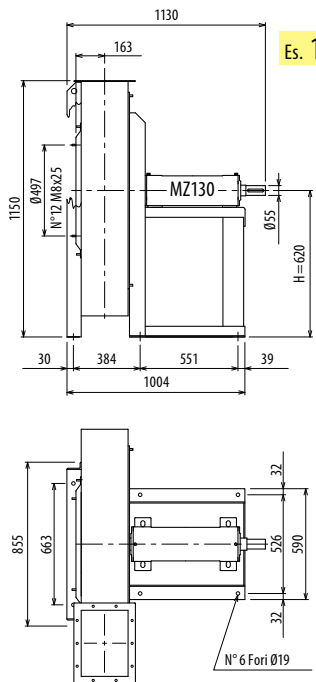

Es. 1

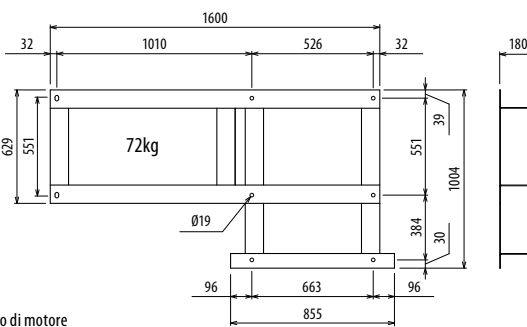
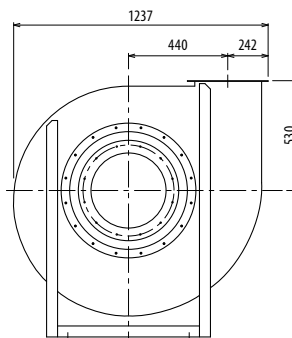

Il ventilatore in ES. 4 senza supporto anteriore è orientabile, in ES. 1 non è orientabile • Peso in tabella comprensivo di motore

■ Le ventilateur en Ex. 4 sans support frontal est orientable, en Ex. 1 n'est pas orientable.
 Le poids dans le tableau inclut le moteur

■ The fan in Ex. 4 without front support is revolvable, in Ex. 1 is not revolvable.
 The weight indicated in the table includes motor

■ Der Ventilator in Aus. 4, ohne Vorderhalterung, ist drehbar; in Aus. 1 ist nicht drehbar.
 Gewichtsangabe in Tabelle inkl. Motor

■ El ventilador en Ej. 4 sin soporte delantero es orientable, en Ej. 1 no es orientable.
 El peso en la tabla incluye el motor

Ulteriori informazioni e quote:

- Ulérieures informations et cotes:
- Further information and sizes:
- Weitere Infos und Größen:
- Más informaciones y medidas:

TIPO - Type		PESO Weight	PD ²											
VENTILATORE Fan	MOTORE Motor	Kg	Kgf x m ²	B	I	H	H1	H2	J	K	M	Q	R	Ø
VI800/N2R	225 M2	583	13	1043	421	710	530	710	556	616	540	80	39	19
VI800/N2R	250 M2	623	13	1151	501	710	530	710	604	690	600	60	39	19
VI800/N2	250 M2	625	16	1151	501	710	530	710	604	690	600	60	39	19
VI800/N2	280 S2	868	16	1154	591	710	530	710	690	750	697	60	46	21
VI800/N/T		346	16			620	530	710						

pg. / s. 4,6

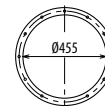

pg. / s. 4,5

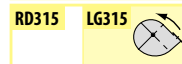
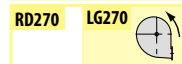
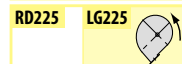
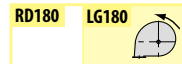
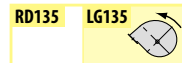
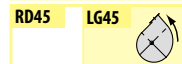
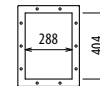

VI

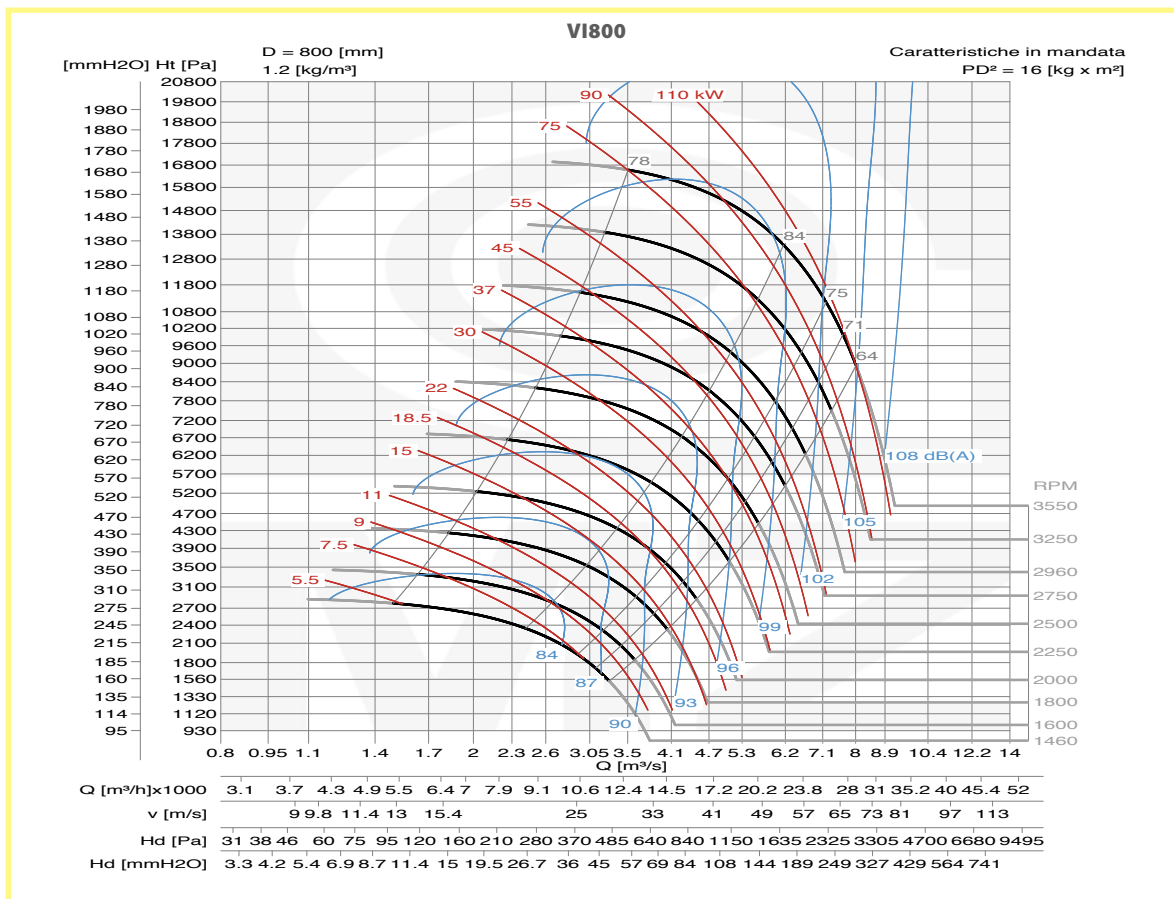

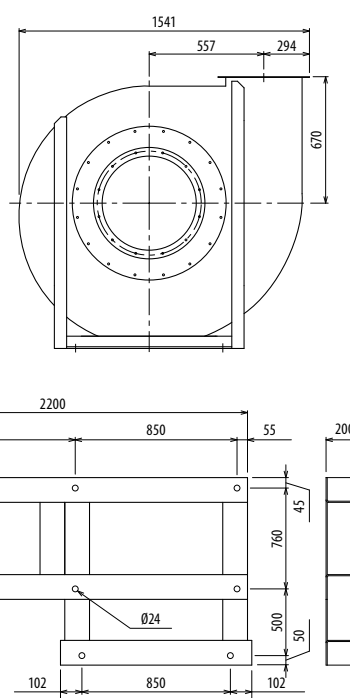
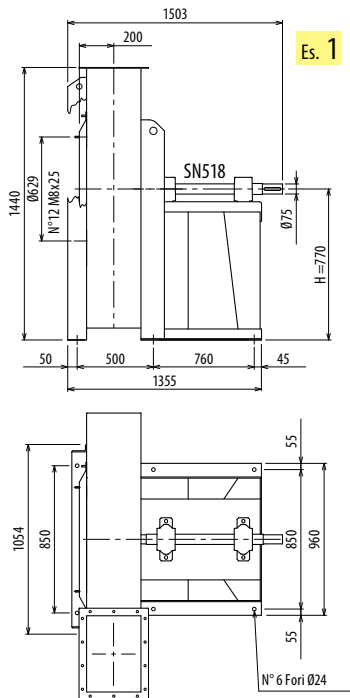
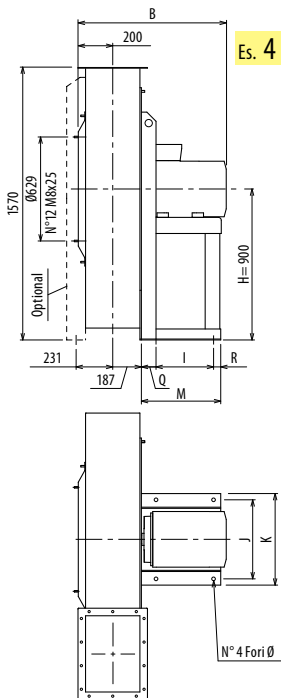

Il ventilatore in Es. 4 senza supporto anteriore è orientabile, in Es. 1 non è orientabile • Peso in tabella comprensivo di motore

■ Le ventilateur en Ex. 4 sans support frontal est orientable, en Ex. 1 n'est pas orientable.
Le poids dans le tableau inclut le moteur
■ Der Ventilator in Aus. 4, ohne Vorderhalterung, ist drehbar; in Aus. 1 ist nicht drehbar.
Gewichtsangabe in Tabelle inkl. Motor

■ The fan in Ex. 4 without front support is revolvable, in Ex. 1 is not revolvable.
The weight indicated in the table includes motor
■ El ventilador en Ej. 4 sin soporte delantero es orientable, en Ej. 1 no es orientable.
El peso en la tabla incluye el motor

Ulteriori informazioni e quote:
■ Ulérieures informations et cotes:
■ Further information and sizes:
■ Weitere Infos und Größen:
■ Más informaciones y medidas:

TIPO - Type		PESO Weight Kg	PD ² Kg x m ²	B	I	H	H1	H2	J	K	M	Q	R	Ø
VENTILATORE Fan	MOTORE Motor													
VI1000/N2R	315 LA2	1561	48	1599	675	900	670	900	760	865	800	80	45	24
VI1000/N2	315 LB2	1580	53	1599	675	900	670	900	760	865	800	80	45	24
VI1000/N/T		680	53			770	670	900						

pg. / s. 4,6

pg. / s. 4,5

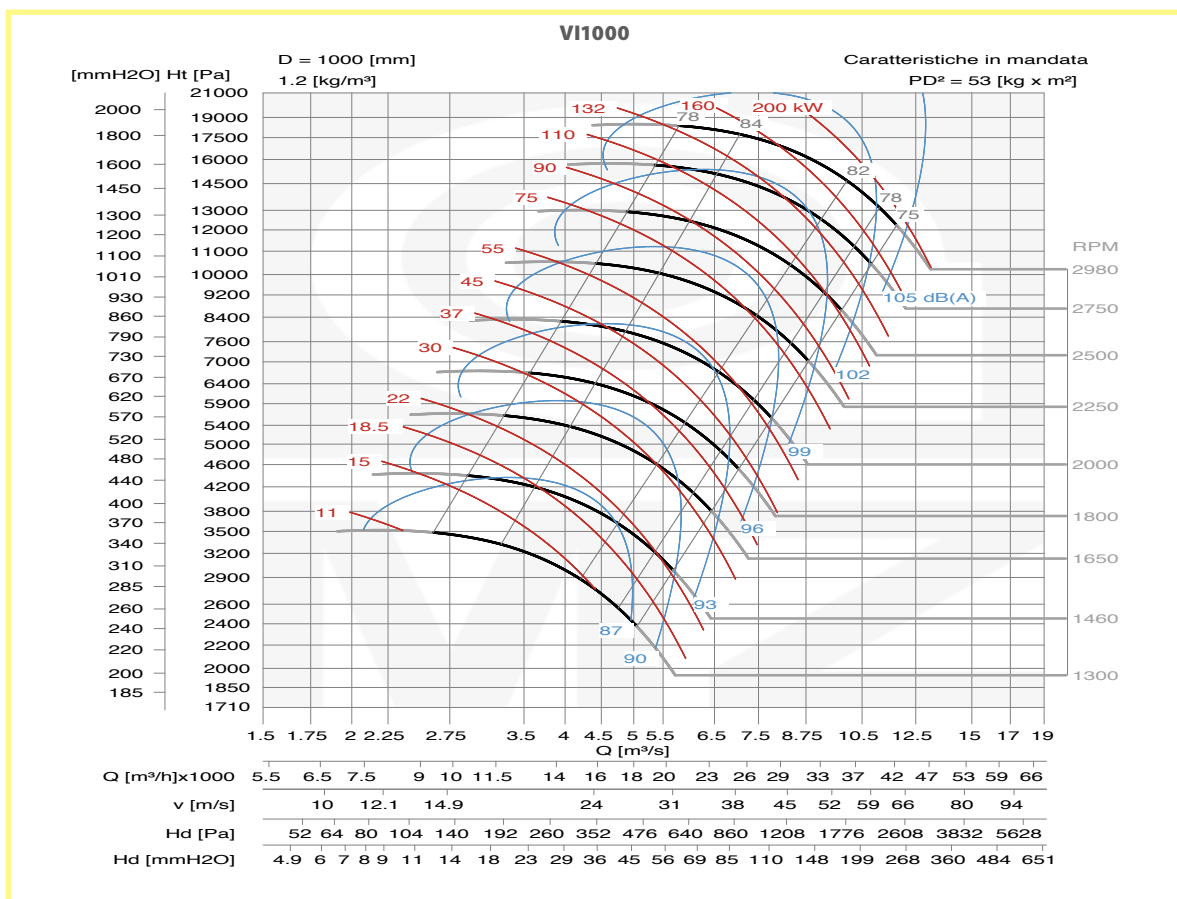
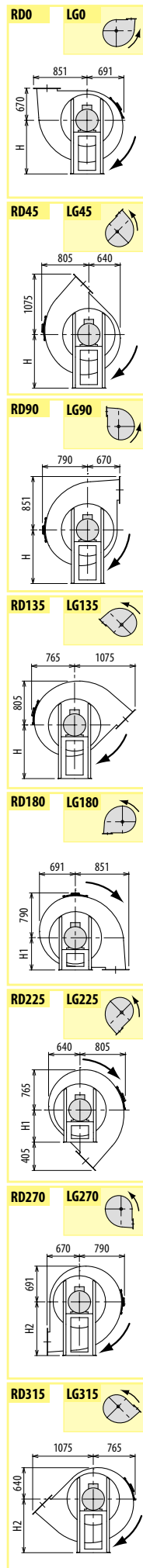
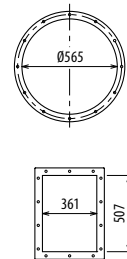

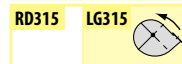
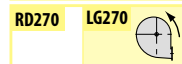
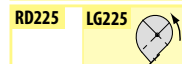
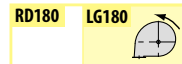
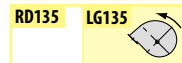
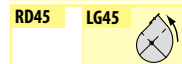
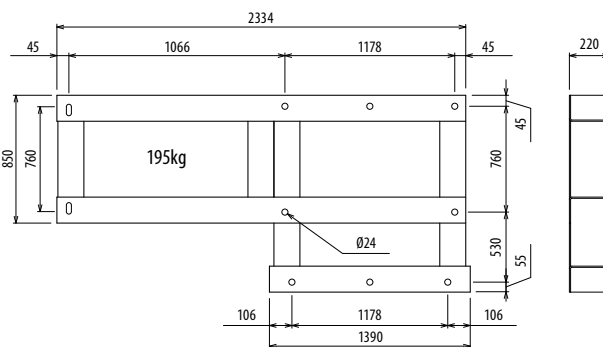
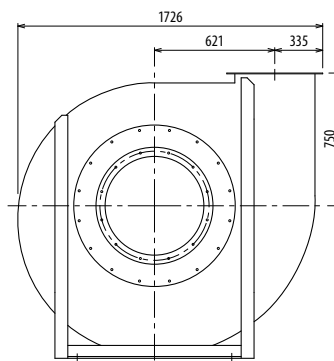
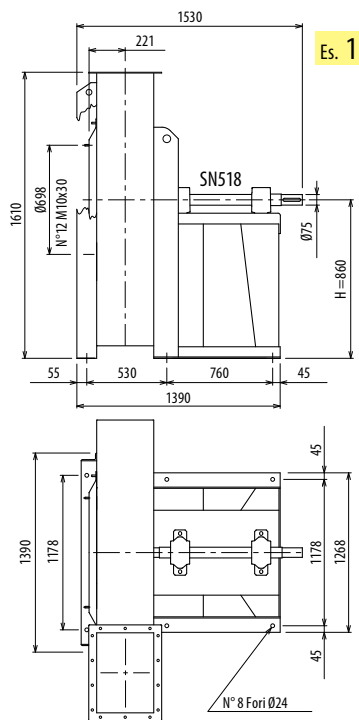

Il ventilatore non è orientabile

■ Le ventilateur n'est pas orientable

■ The fan is not revolvable

■ Der Ventilator ist nicht drehbar

■ El ventilador no es orientable

Ulteriori informazioni e quote:

■ Ulérieures informations et cotes:

■ Further information and sizes:

■ Weitere Infos und Größen:

■ Más informaciones y medidas:

TIPO - Type		PESO Weight	PD ²											pg./S. 4,6
VENTILATORE Fan	MOTORE Motor	Kg	Kgf x m ²	B	I	H	H1	H2	H3	H4	M			
VI1120/N/T		800	87			860	750	1000	860	1000				

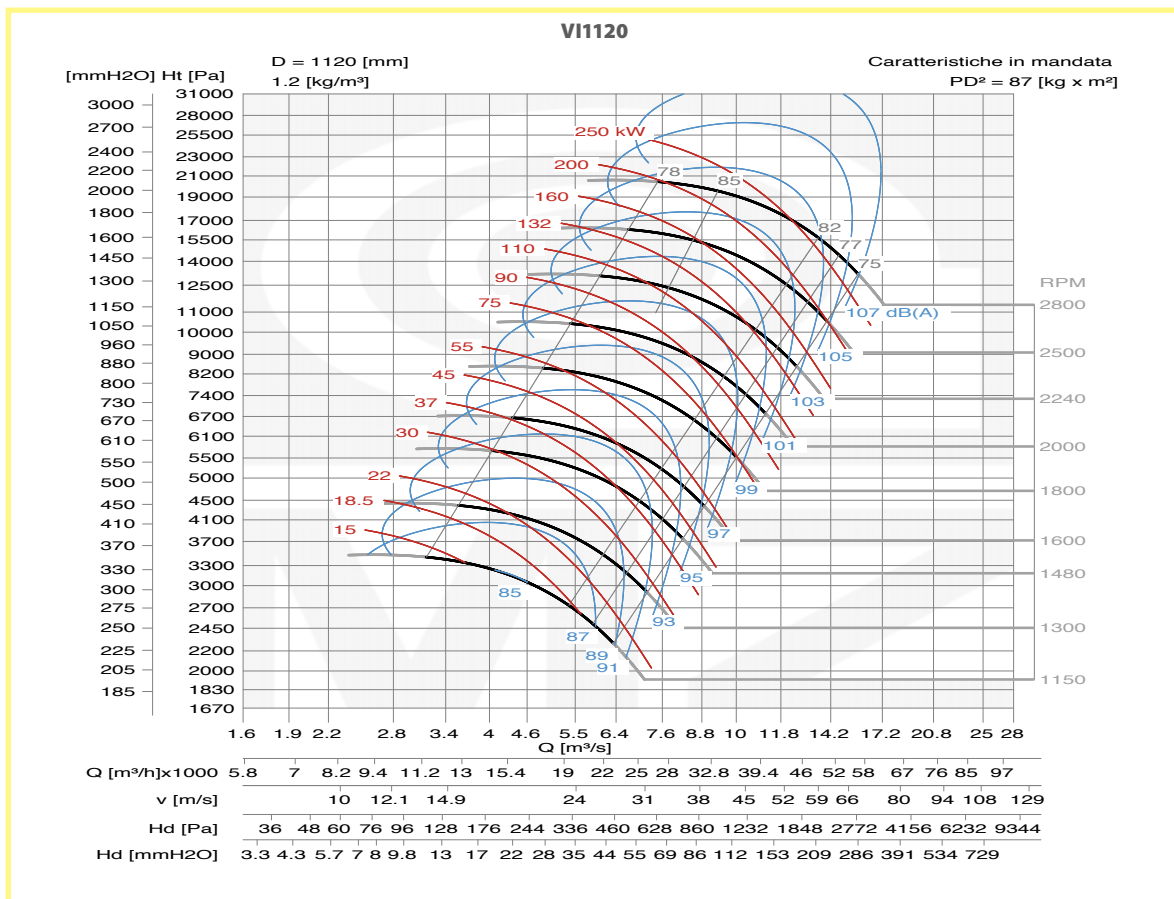
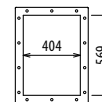

VI

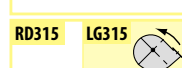
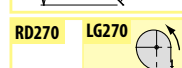
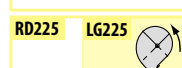
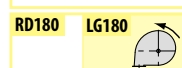
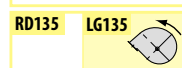
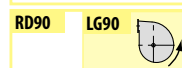
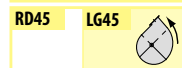
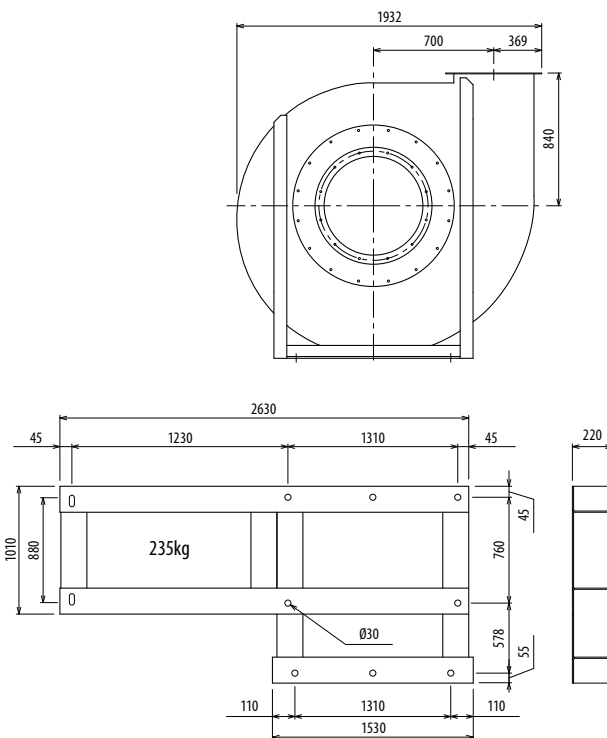
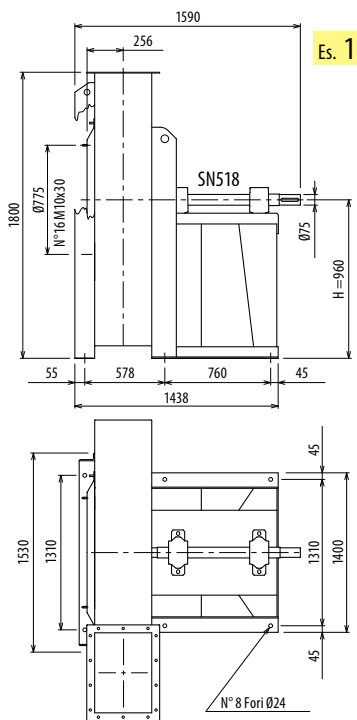

Il ventilatore non è orientabile

■ Le ventilateur n'est pas orientable

■ The fan is not revolvable

■ Der Ventilator ist nicht drehbar

■ El ventilador no es orientable

Ulteriori informazioni e quote:

- Ulérieures informations et cotes:
- Further information and sizes:
- Weitere Infos und Größen:
- Más informaciones y medidas:

TIPO - Type		PESO Weight	PD ²										
VENTILATORE Fan	MOTORE Motor	Kg	Kgf x m ²	B	I	H	H1	H2	H3	H4	M	pg./s. 4,6	
VI1250/N/T		1150	157			960	840	1120	960	1120		pg./s. 4,5	

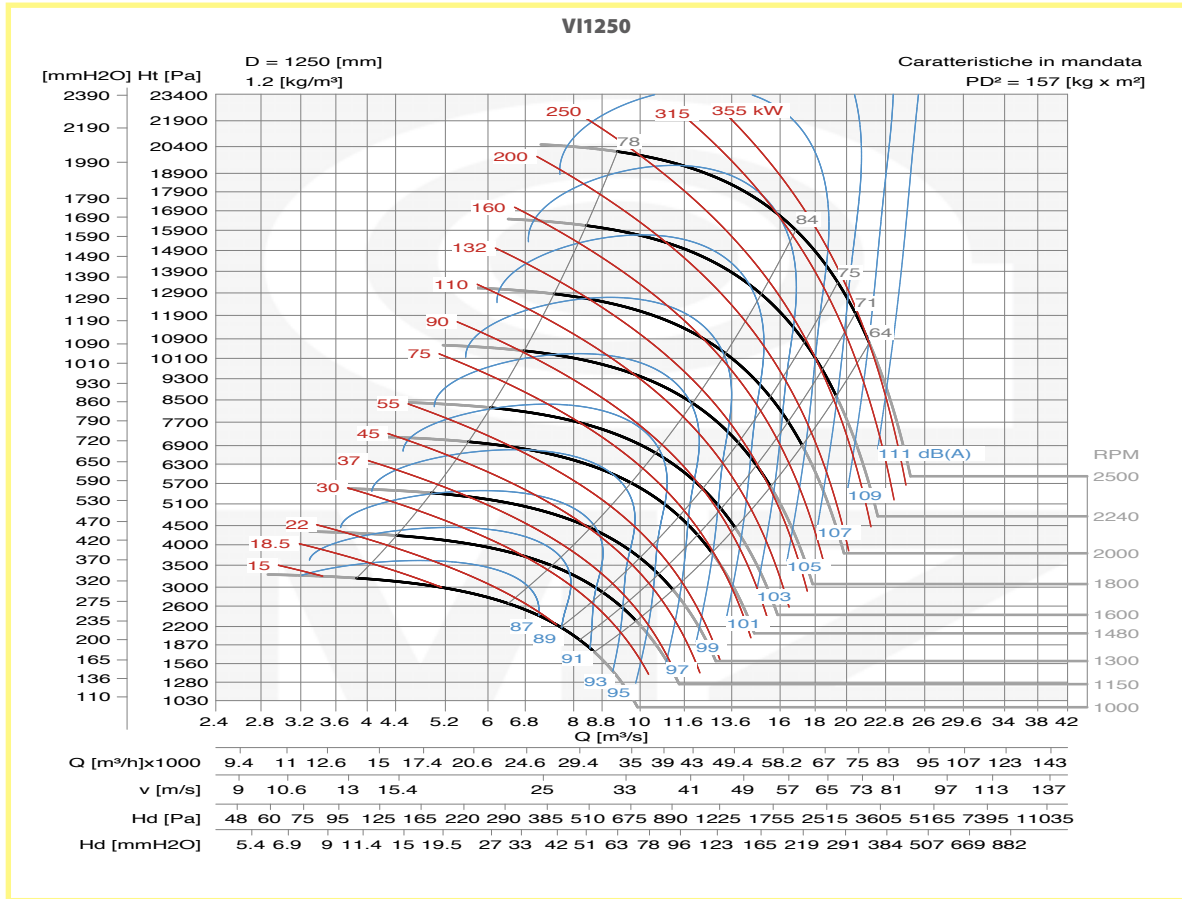
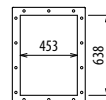

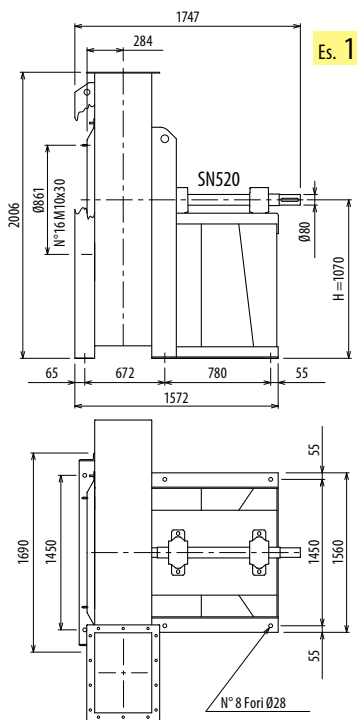

Es. 1

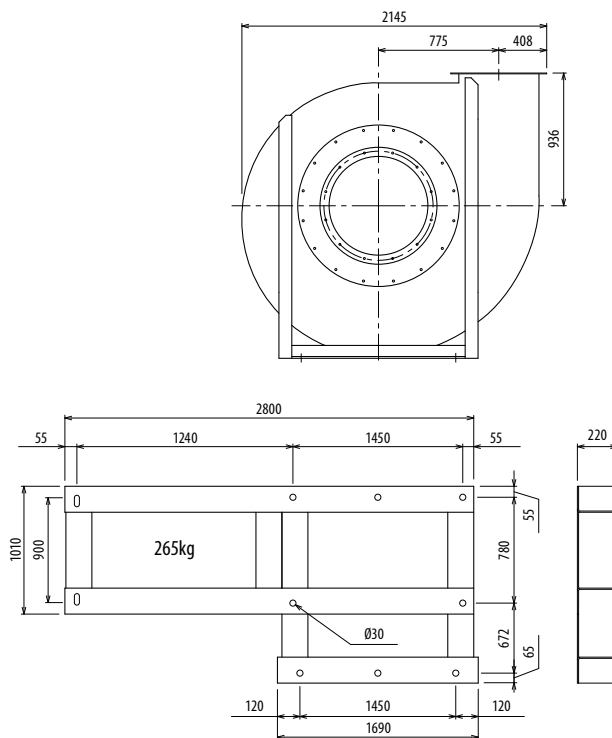

Il ventilatore non è orientabile

■ Le ventilateur n'est pas orientable

■ The fan is not revolvable

■ Der Ventilator ist nicht drehbar

■ El ventilador no es orientable

Ulteriori informazioni e quote:

- Ulérieures informations et cotes:
- Further information and sizes:
- Weitere Infos und Größen:
- Más informaciones y medidas:

TIPO - Type		PESO Weight	PD ²										
VENTILATORE Fan	MOTORE Motor	Kg	Kgf x m ²	B	I	H	H1	H2	H3	H4	M		
VI1400/N/T		1300	275			1070	936	1200	1070	1200			pg. / s. 4,6

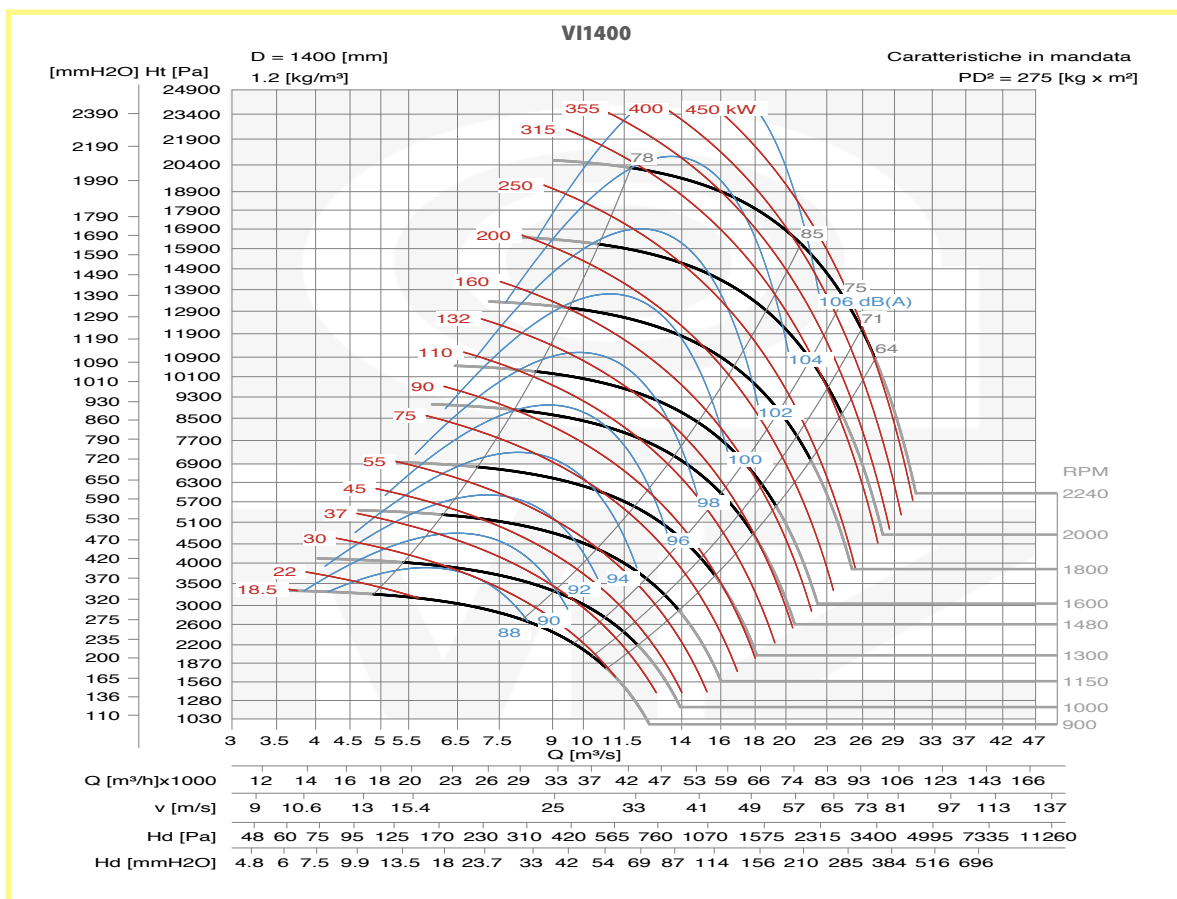
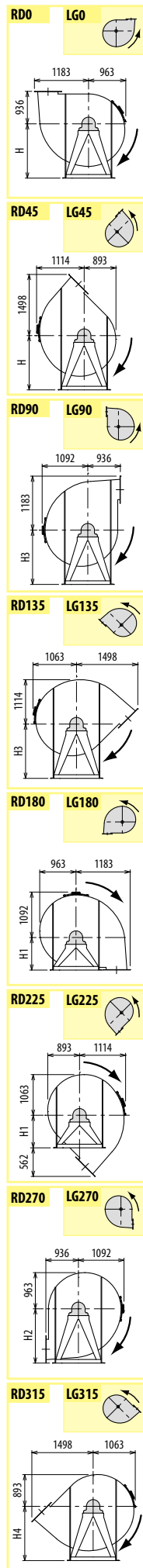
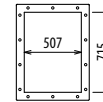
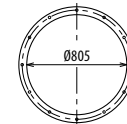

VI

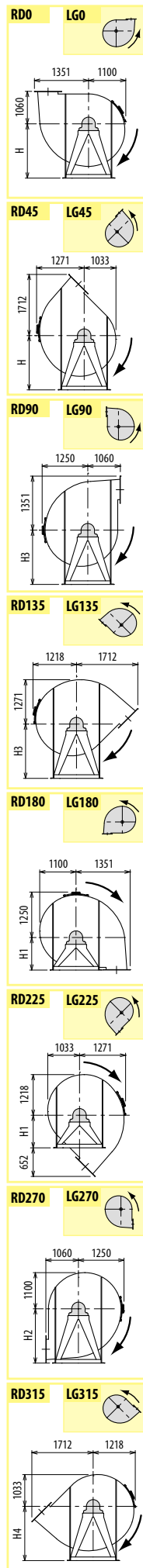
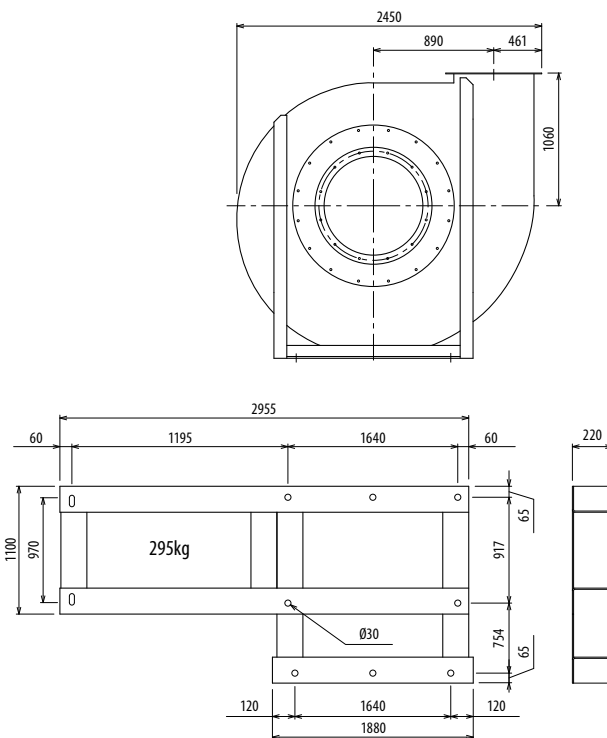
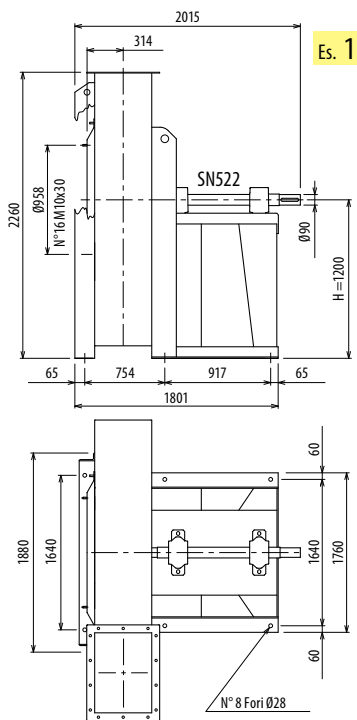

Il ventilatore non è orientabile

■ Le ventilateur n'est pas orientable

■ The fan is not revolvable

■ Der Ventilator ist nicht drehbar

■ El ventilador no es orientable

Ulteriori informazioni e quote:

- Ulérieures informations et cotes:
- Further information and sizes:
- Weitere Infos und Größen:
- Más informaciones y medidas:

TIPO - Type		PESO Weight	PD ²										
VENTILATORE Fan	MOTORE Motor	Kg	Kgf x m ²	B	I	H	H1	H2	H3	H4	M	pg./s. 4,6	
VI1600/N/T		1800	370			1200	1060	1400	1120	1400		pg./s. 4,5	

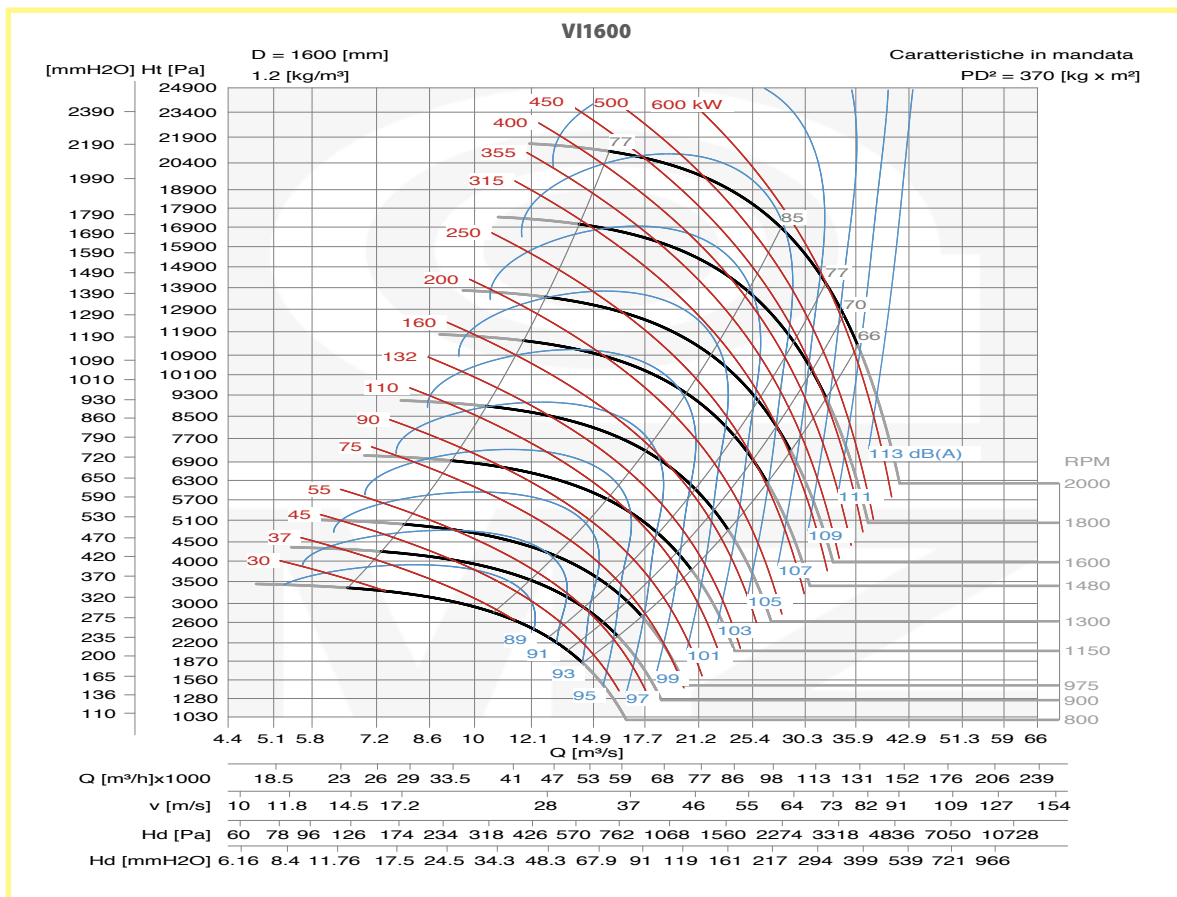
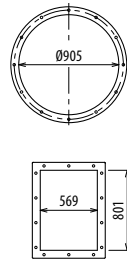

VI

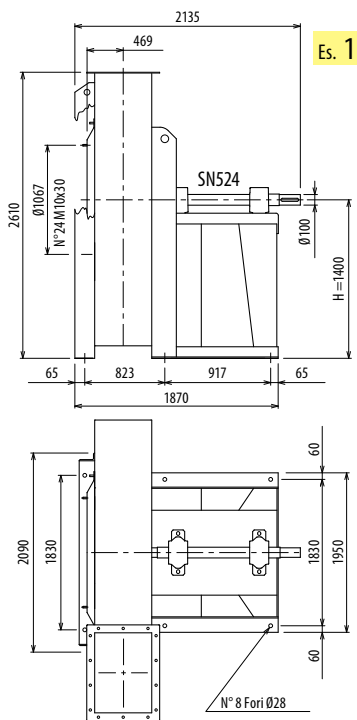

Es. 1

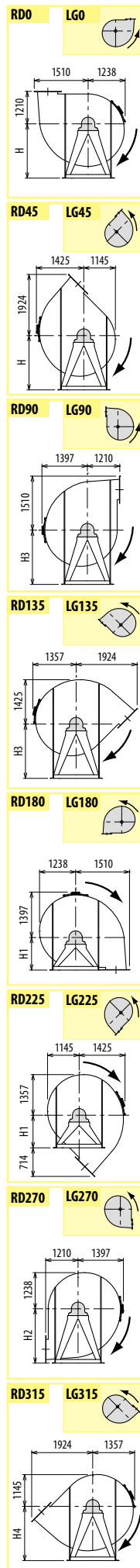
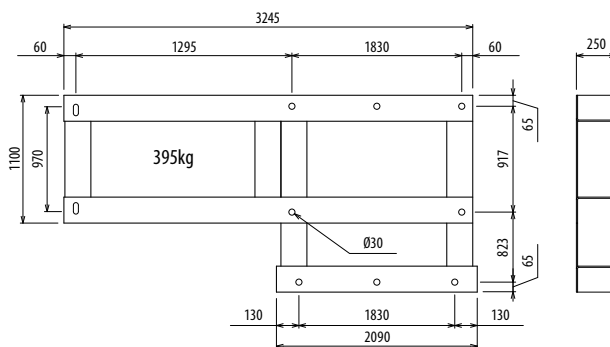
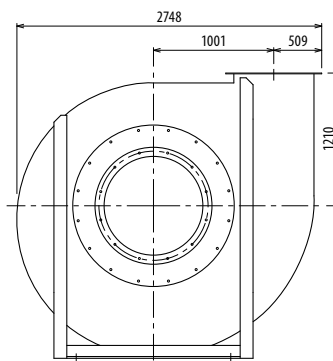

Il ventilatore non è orientabile

■ Le ventilateur n'est pas orientable

■ The fan is not revolvable

■ Der Ventilator ist nicht drehbar

■ El ventilador no es orientable

Ulteriori informazioni e quote:

■ Ulérieures informations et cotes:

■ Further information and sizes:

■ Weitere Infos und Größen:

■ Más informaciones y medidas:

TIPO - Type		PESO Weight	PD ²										
VENTILATORE Fan	MOTORE Motor	Kg	Kgf x m ²	B	I	H	H1	H2	H3	H4	M	pg. / s.	
VI1800/N/T		2420	640			1400	1210	1550	1250	1400		4,6	

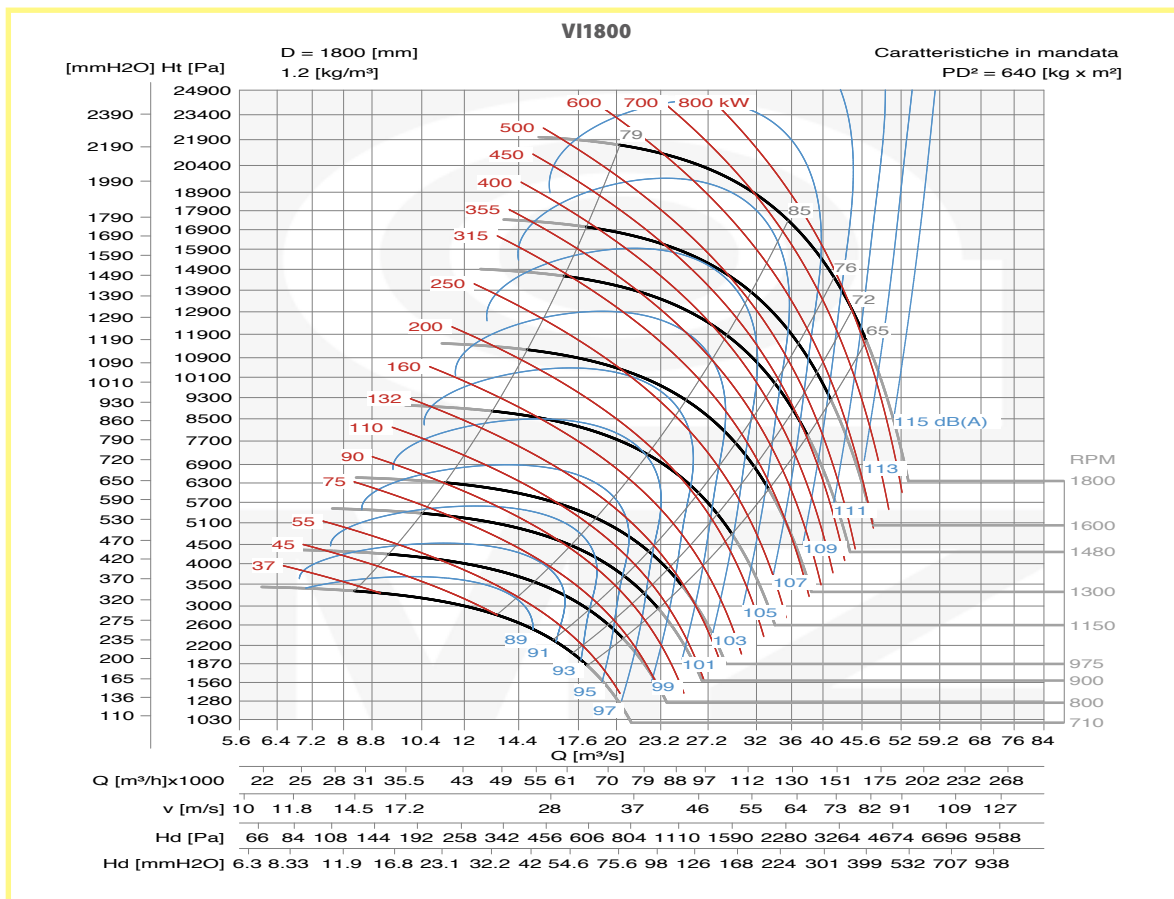
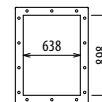
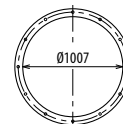

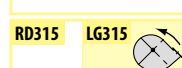
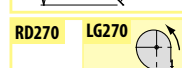
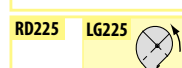
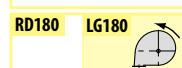
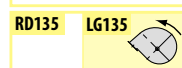
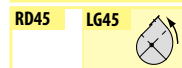
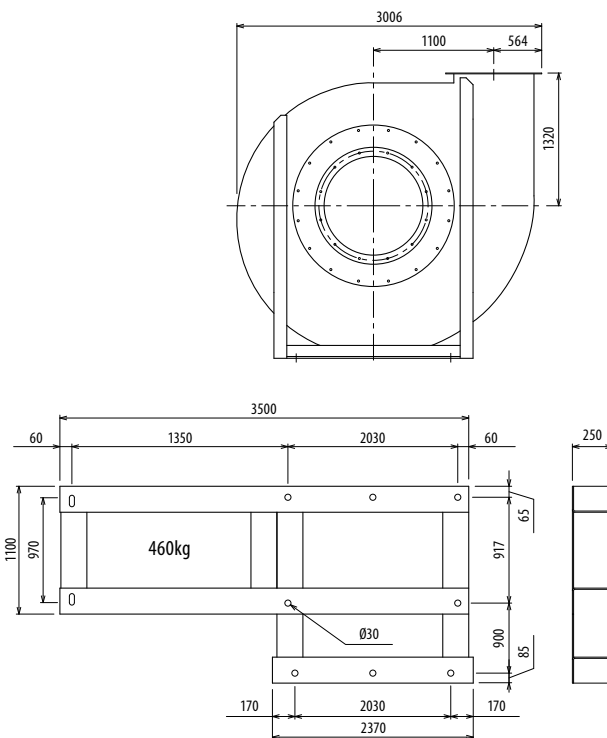
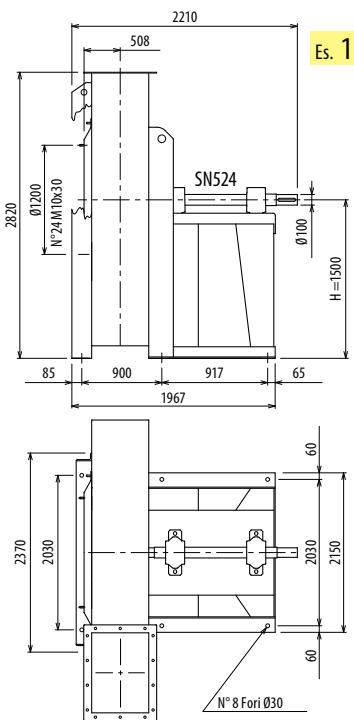

Il ventilatore non è orientabile

■ Le ventilateur n'est pas orientable

■ The fan is not revolvable

■ Der Ventilator ist nicht drehbar

■ El ventilador no es orientable

Ulteriori informazioni e quote:

- Ulérieures informations et cotes:
- Further information and sizes:
- Weitere Infos und Größen:
- Más informaciones y medidas:

TIPO - Type		PESO Weight	PD ²										
VENTILATORE Fan	MOTORE Motor	Kg	Kgf x m ²	B	I	H	H1	H2	H3	H4	M	pg. / s. 4,6	pg. / s. 4,5
VI2000/N/T		3110	1190			1500	1320	1800	1400	1600			

